



# Dell™ PowerEdge™ 6850 Systems Installation and Troubleshooting Guide

[Introduction](#)  
[Indicators, Messages, and Codes](#)  
[Finding Software Solutions](#)  
[Running the System Diagnostics](#)  
[Troubleshooting Your System](#)  
[Installing System Components](#)  
[Installing Drives](#)  
[Getting Help](#)  
[Jumpers, Switches, and Connectors](#)  
[I/O Connectors](#)  
[Service-Only Parts Replacement Procedures](#)

---

## Notes, Notices, and Cautions

-  **NOTE:** A NOTE indicates important information that helps you make better use of your computer.
-  **NOTICE:** A NOTICE indicates either potential damage to hardware or loss of data and tells you how to avoid the problem.
-  **CAUTION:** A CAUTION indicates a potential for property damage, personal injury, or death.

## Abbreviations and Acronyms

For a complete list of abbreviations and acronyms, see the Glossary in your *User's Guide*.

---

Information in this document is subject to change without notice.  
© 2005 Dell Inc. All rights reserved.

Reproduction in any manner whatsoever without the written permission of Dell Inc. is strictly forbidden.

Trademarks used in this text: *Dell*, the *DELL* logo, *PowerEdge*, *PowerVault*, *Dell OpenManage*, *Dimension*, *Inspiron*, *OptiPlex*, *Latitude*, *Dell Precision*, *PowerApp*, *PowerConnect*, and *DellNet* are trademarks of Dell Inc.; *Intel* is a registered trademark and *Xeon* is a trademark of Intel Corporation.

Other trademarks and trade names may be used in this document to refer to either the entities claiming the marks and names or their products. Dell Inc. disclaims any proprietary interest in trademarks and trade names other than its own.

*Initial release: 28 Mar 2005*

## Jumpers, Switches, and Connectors

### Dell™ PowerEdge™ 6850 Systems Installation and Troubleshooting Guide

- [Jumpers—A General Explanation](#)
- [System Board Jumpers](#)
- [System Board Connectors](#)
- [Memory Riser Card Connectors](#)
- [SCSI Backplane Connectors](#)
- [Disabling a Forgotten Password](#)

---

This section provides specific information about the system jumpers. It also provides some basic information on jumpers and switches and describes the connectors on the various boards in the system.

---

## Jumpers—A General Explanation

Jumpers provide a convenient and reversible way of reconfiguring the circuitry on a printed circuit board. When reconfiguring the system, you may need to change jumper settings on circuit boards or drives.

### Jumpers

Jumpers are small blocks on a circuit board with two or more pins emerging from them. Plastic plugs containing a wire fit down over the pins. The wire connects the pins and creates a circuit. To change a jumper setting, pull the plug off its pin(s) and carefully fit it down onto the pin(s) indicated. [Figure A-1](#) shows an example of a jumper.

**Figure A-1. Example Jumper**

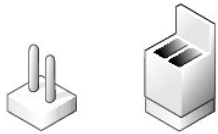

A jumper is referred to as open or unjumped when the plug is pushed down over only one pin or if there is no plug at all. When the plug is pushed down over two pins, the jumper is referred to as jumped. The jumper setting is often shown in text as two numbers, such as 1–2. The number 1 is printed on the circuit board with a triangle so that you can identify each pin number based on the location of pin 1.

[Figure A-2](#) shows the location and default settings of the server-module jumper blocks. See [Table A-1](#) for the designations, default settings, and functions of the jumpers.

---

## System Board Jumpers



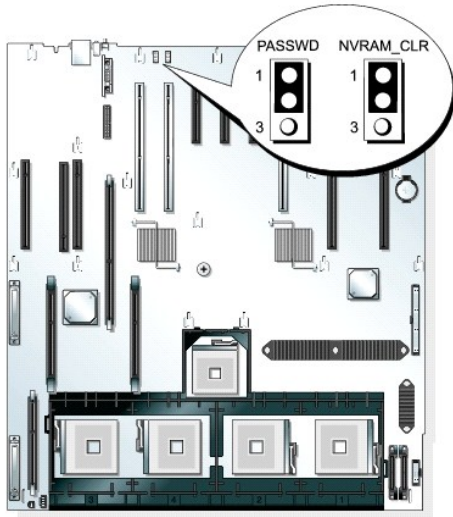

[Figure A-2](#) shows the location of the configuration jumpers on the system board. [Table A-1](#) lists the jumper settings.

 **NOTE:** To access the jumpers, remove any expansion cards installed in slots 6 and 7. See [Figure A-3](#).

**Figure A-2. System Board Jumpers**



**Table A-1. System Board Jumper Settings**

Jumper	Setting	Description
PASSWD	 (default)	The password feature is enabled.
		The password feature is disabled.
NVRAM_CLR	 (default)	The configuration settings in NVRAM are retained at system boot.
		The configuration settings in NVRAM are cleared at next system boot.

## System Board Connectors

See [Figure A-3](#) and [Table A-2](#) for the location and description of the system board connectors.

**Figure A-3. System Board Connectors**

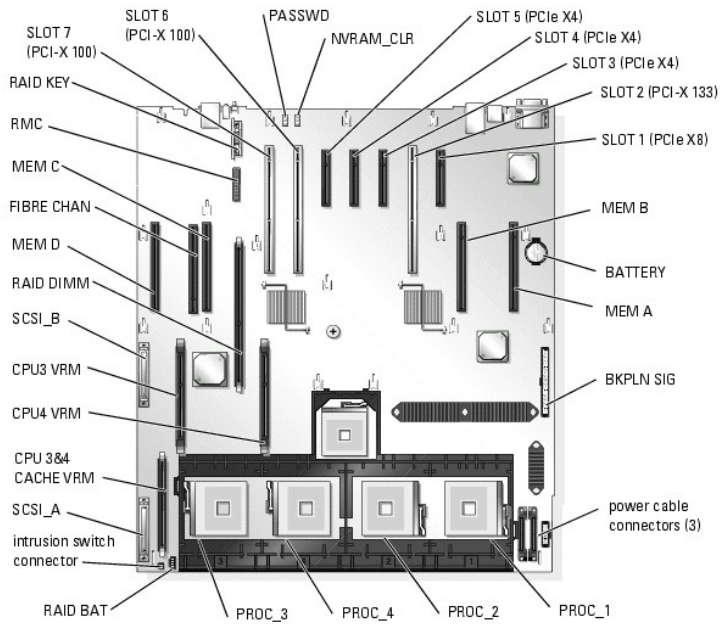

**Table A-2. System Board Connectors**

Connector	Description
BATTERY	Connector for the 3.0-V coin battery
BKPLN SIG	Backplane interface cable connector
PROC_n	Processor connector (4)
CPU3 VRM, CPU4 VRM	Voltage regulator modules (VRMs) for processors 3 and 4
CPU 3&4 CACHE VRM	Reserved
FIBRE CHAN	Integrated Fiber Channel module card
MEM A, B, C, D	Memory riser card connector (4)
NVRAM_CLR	NVRAM jumper. See <a href="#">Table A-1</a> .
PASSWD	Password jumper. See <a href="#">Table A-1</a> .
SCSI_A, SCSI_B	Connectors for the integrated SCSI controller (2)
SLOTT n	Expansion slot connector (7)
RAID_BAT	Connector for the optional RAID battery
RAID_DIMM	Connector for the optional RAID memory module
RAID_KEY	Connector for the optional RAID key
RMC	Connector for the remote access controller (RAC)

## Memory Riser Card Connectors

See [Figure A-4](#) for the location of the connectors on the memory riser card.

**Figure A-4. Memory Riser Card Connectors**

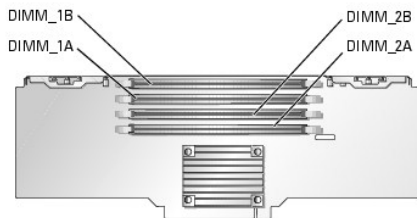

---

## SCSI Backplane Connectors

See [Figure A-5](#) for the location and description of the connectors on the back of the SCSI backplane board.

Figure A-5. Connectors on Back of SCSI Backplane

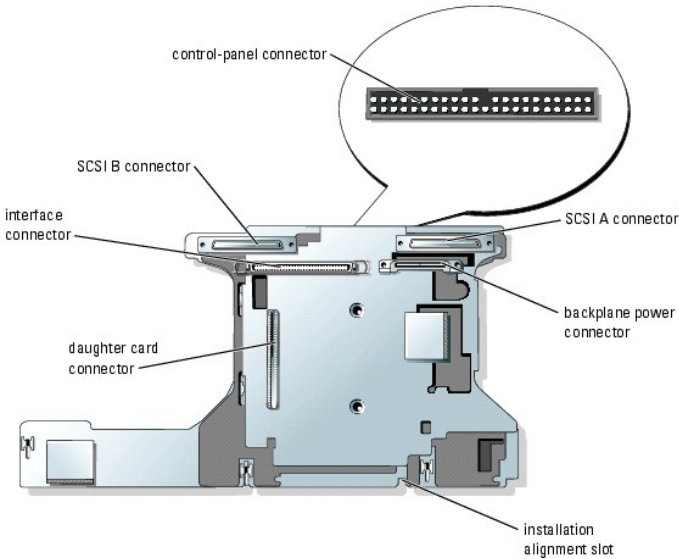

---

## Disabling a Forgotten Password

The system's software security features include a system password and a setup password, which are discussed in detail in "Using the System Setup Program" in your *User's Guide*. The password jumper enables these password features or disables them and clears any password(s) currently in use.

**⚠ CAUTION:** Many repairs may only be done by a certified service technician. You should only perform troubleshooting and simple repairs as authorized in your product documentation, or as directed by the online or telephone service and support team. Damage due to servicing that is not authorized by Dell is not covered by your warranty. Read and follow the safety instructions that came with the product.

1. Turn off the system and attached peripherals, and disconnect the system from the electrical outlet.
2. Open the system. See "[Opening the System](#)" in "Troubleshooting Your System."
3. Remove the expansion card from expansion slots 6 and 7, if installed. See "[Expansion Cards](#)" in "Installing System Components."
4. Remove the password jumper plug from pins 1 and 2 and place it on pins 2 and 3.

See [Figure A-2](#) to locate the password jumper on the system board.

5. Replace the expansion cards in expansion slots 6 and 7, if removed. See "[Expansion Cards](#)" in "Installing System Components."
6. Close the system. See "[Closing the System](#)" in "Troubleshooting Your System."
7. Reconnect the system to the electrical outlet, and turn on the system.

The existing passwords are not disabled (erased) until the system boots with the password jumper plug on pins 2 and 3. However, before you assign a new system and/or setup password, you must install the jumper plug on pins 1 and 2.

**🔧 NOTE:** If you assign a new system and/or setup password with the jumper plug still removed, the system disables the new password(s) the next time it boots.

8. Turn off the system, including any attached peripherals, and disconnect the system from the electrical outlet.
9. Open the system. See "[Opening the System](#)" in "Troubleshooting Your System."

10. Remove the expansion cards from expansion slots 6 and 7, if installed. See "[Expansion Cards](#)" in "Installing System Components."
  11. Reinstall the password jumper plug on pins 1 and 2 to enable the password protection feature.
  12. Replace the expansion cards in expansion slots 6 and 7, if removed. See "[Expansion Cards](#)" in "Installing System Components."
  13. Close the system, reconnect the system to the electrical outlet, and turn on the system.
  14. Assign a new system and/or setup password.  
To assign a new password using the System Setup program, see "Using the System Setup Program" in your *User's Guide*.
- 

[Back to Contents Page](#)

## I/O Connectors

### Dell™ PowerEdge™ 6850 Systems Installation and Troubleshooting Guide

- [Serial Connector](#)
- [Video Connector](#)
- [USB Connectors](#)
- [Integrated NIC Connectors](#)
- [Network Cable Requirements](#)

I/O connectors are the gateways that the system uses to communicate with external devices, such as a keyboard, mouse, printer, or monitor. This section describes the various connectors on your system. If you reconfigure the hardware connected to the system, you may also need the pin number and signal information for these connectors. [Figure B-1](#) illustrates the connectors on the system.

Figure B-1. I/O Connectors

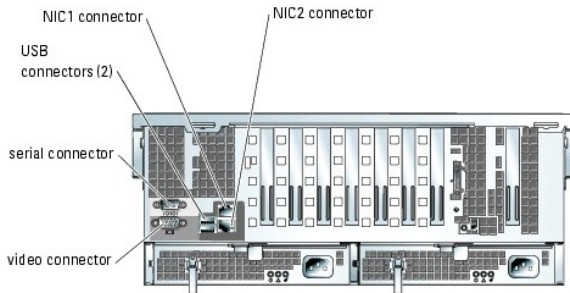

[Table B-1](#) shows the icons used to label the connectors on the system.

Table B-1. I/O Connector Icons

Icon	Connector
	Serial connector
	Video connector
	USB connector
	NIC connector

## Serial Connector

Serial connectors support devices such as external modems, printers, and mice that require serial data transmission. The serial connector is also used by the BMC to provide remote access to the system. The serial connector uses a 9-pin D-subminiature connector.

## Serial Connector Autoconfiguration

The default designation of the integrated serial connector is COM1. When you add an expansion card containing a serial connector that has the same designation as the integrated connector, the system's autoconfiguration feature remaps (reassigns) the integrated serial connector to the next available designation. Both the new and the remapped COM connectors share the same IRQ setting. COM1 and COM3 share IRQ4, while COM2 and COM4 share IRQ3.

**NOTE:** If two COM connectors share an IRQ setting, you may not be able to use them both at the same time. In addition, if you install one or more expansion cards with serial connectors designated as COM1 and COM3, the integrated serial connector is disabled.

Before adding a card that remaps the COM connectors, check the documentation that came with the software to make sure that the software can accommodate the new COM connector designation.

[Figure B-2](#) illustrates the pin numbers for the serial connector and [Table B-2](#) defines the pin assignments for the connector.

Figure B-2. Serial Connector Pin Numbers

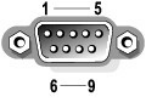

**Table B-2. Serial Connector Pin Assignments**

Pin	Signal	I/O	Definition
1	DCD	I	Data carrier detect
2	SIN	I	Serial input
3	SOUT	O	Serial output
4	DTR	O	Data terminal ready
5	GND	N/A	Signal ground
6	DSR	I	Data set ready
7	RTS	O	Request to send
8	CTS	I	Clear to send
9	RI	I	Ring indicator
Shell	N/A	N/A	Chassis ground

## Video Connector

You can attach a VGA-compatible monitor to the system's integrated video controller using a 15-pin high-density D-subminiature connector on the system front or back panel. [Figure B-3](#) illustrates the pin numbers for the video connector and [Table B-3](#) defines the pin assignments for the connector.

**NOTE:** Installing a video card automatically disables the system's integrated video controller.

**Figure B-3. Video Connector Pin Numbers**

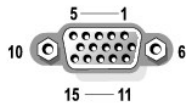

**Table B-3. Video Connector Pin Assignments**

Pin	Signal	I/O	Definition
1	RED	O	Red video
2	GREEN	O	Green video
3	BLUE	O	Blue video
4	NC	N/A	No connection
5-8, 10	GND	N/A	Signal ground
9	VCC	N/A	Vcc
11	NC	N/A	No connection
12	DDC data out	O	Monitor detect data
13	HSYNC	O	Horizontal synchronization
14	VSYNC	O	Vertical synchronization
15	NC	N/A	No connection

## USB Connectors

The system's USB connectors support USB-compliant peripherals such as keyboards, mice, and printers and may also support USB-compliant devices such as diskette drives and optical drives. [Figure B-4](#) illustrates the pin numbers for the USB connector and [Table B-4](#) defines the pin assignments for the connector.

**NOTE:** Do not attach a USB device or a combination of USB devices that draw a maximum current of more than 500 mA per channel or +5 V. Attaching devices that exceed this threshold may cause the USB connectors to shut down. See the documentation that accompanied the USB devices for their maximum current ratings.



Figure B-4. USB Connector Pin Numbers



Table B-4. USB Connector Pin Assignments

Pin	Signal	I/O	Definition
1	Vcc	N/A	Supply voltage
2	DATA	I	Data in
3	+DATA	O	Data out
4	GND	N/A	Signal ground

## Integrated NIC Connectors

Each of the system's integrated NICs function as a separate network expansion card while providing fast communication between servers and workstations. [Figure B-5](#) illustrates the pin numbers for the NIC connector and [Table B-5](#) defines the pin assignments for the connectors.

Figure B-5. NIC Connector

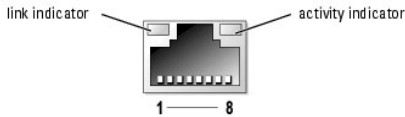

Table B-5. NIC Connector Pin Assignments

Pin	Signal	I/O	Definition
1	TD+	O	Data out (+)
2	TD-	O	Data out (-)
3	RD+	I	Data in (+)
4	NC	N/A	No connection
5	NC	N/A	No connection
6	RD-	I	Data in (-)
7	NC	N/A	No connection
8	NC	N/A	No connection

## Network Cable Requirements

The NIC supports a UTP Ethernet cable equipped with a standard RJ45-compatible plug.

Observe the following cabling restrictions.

🔔 **NOTICE:** To avoid line interference, voice and data lines must be in separate sheaths.

- 1 Use Category 5 or greater wiring and connectors.
- 1 Do not exceed a cable run length (from a workstation to a hub) of 100 m (328 ft).

For detailed guidelines on operation of a network, see "Systems Considerations of Multi-Segment Networks" in the IEEE 802.3 standard.

[Back to Contents Page](#)

## Service-Only Parts Replacement Procedures

### Dell™ PowerEdge™ 6850 Systems Installation and Troubleshooting Guide

- [Before You Begin](#)
  - [Recommended Tools](#)
  - [Control-Panel Assembly](#)
  - [Fan Interposer Board](#)
  - [SCSI Backplane](#)
  - [System Board](#)
  - [Power Distribution Board](#)
  - [Chassis Intrusion Switch](#)
- 

## Before You Begin

**⚠ CAUTION:** See your *Product Information Guide* for complete information about safety precautions, working inside the computer, and protecting against electrostatic discharge.

The procedures in this document require that you remove the cover and work inside the system. While working inside the system, do not attempt to service the system except as explained in this document and the *User's Guide* available on [support.dell.com](http://support.dell.com). Always follow the instructions closely, and ensure that you review all safety precautions in the *Product Information Guide*.

---

## Recommended Tools

You may need the following items to perform the procedures in this section:

- 1 #2 Phillips screwdriver
  - 1 Wrist grounding strap
- 

## Control-Panel Assembly

### Removing the Control Panel

**⚠ CAUTION:** Many repairs may only be done by a certified service technician. You should only perform troubleshooting and simple repairs as authorized in your product documentation, or as directed by the online or telephone service and support team. Damage due to servicing that is not authorized by Dell is not covered by your warranty. Read and follow the safety instructions that came with the product.

1. Turn off the system and attached peripherals, and disconnect the system from the electrical outlet.
2. Open the system. See "[Opening the System](#)" in "Troubleshooting Your System."
3. Remove fan 1. See "[Removing a System Fan](#)" in "Installing System Components."
4. Remove the three control-panel securing screws from the system front panel. See [Figure C-1](#).
5. Lift the control-panel assembly out of the chassis.
6. Disconnect the control-panel cable from the control-panel assembly.

**Figure C-1. Removing and Installing the Control-Panel Assembly**

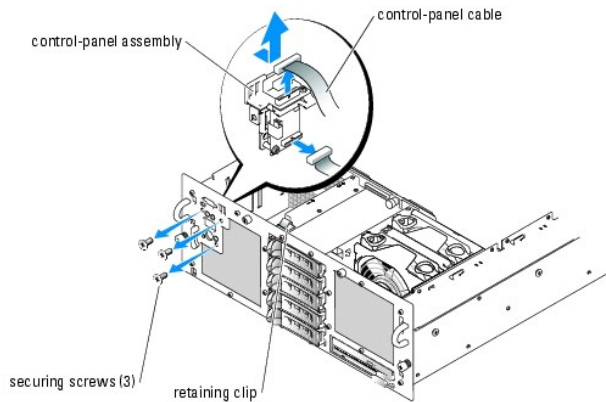

## Installing the Control Panel

**⚠ CAUTION:** Many repairs may only be done by a certified service technician. You should only perform troubleshooting and simple repairs as authorized in your product documentation, or as directed by the online or telephone service and support team. Damage due to servicing that is not authorized by Dell is not covered by your warranty. Read and follow the safety instructions that came with the product.

1. Connect the control-panel cable to the control-panel assembly. See [Figure C-1](#).
2. Lower the control-panel assembly into the system and align it with the front panel.
3. Secure the control-panel assembly to the system front panel with the three control-panel securing screws.
4. Ensure that the control-panel cable is secure in its retaining clip on the chassis.
5. Install fan 1. See "[Installing a System Fan](#)" in "Installing System Components."
6. Close the system. See "[Closing the System](#)" in "Troubleshooting Your System."
7. Reconnect the system to its electrical outlet and turn the system on, including any attached peripherals.

## Fan Interposer Board

### Removing a Fan Interposer Board

**⚠ CAUTION:** Many repairs may only be done by a certified service technician. You should only perform troubleshooting and simple repairs as authorized in your product documentation, or as directed by the online or telephone service and support team. Damage due to servicing that is not authorized by Dell is not covered by your warranty. Read and follow the safety instructions that came with the product.

1. Turn off the system and attached peripherals, and disconnect the system from the electrical outlet.
2. Open the system. See "[Opening the System](#)" in "Troubleshooting Your System."

**🔍 NOTICE:** To prevent damage to the drives and backplane, you must remove the SCSI drives and diskette/optical drive carrier from the system before removing the backplane. You must note the number of each hard drive and temporarily label them before removal so that you can replace them in the same locations.

3. Remove all SCSI hard drives. See "[Removing a SCSI Hard Drive](#)" in "Installing Drives."
4. Remove the optical drive/diskette drive carrier.

To remove the drive carrier, pull the release latch forward, then slide the carrier out of the chassis. See [Figure 7-3](#).

5. Remove fans 1 and 3 or 2 and 4 (depending on which fan interposer board is being replaced). See "[Removing a System Fan](#)" in "Installing System Components."

6. Remove the SCSI backplane. See ["Removing the SCSI Backplane."](#)
7. Remove the two screws and remove the fan interposer board. See [Figure C-2](#).

**Figure C-2. Removing and Installing a Fan Interposer Board**

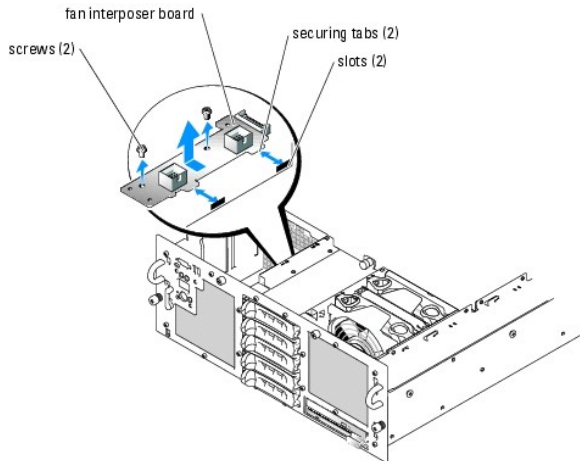

## Installing a Fan Interposer Board

**⚠ CAUTION:** Many repairs may only be done by a certified service technician. You should only perform troubleshooting and simple repairs as authorized in your product documentation, or as directed by the online or telephone service and support team. Damage due to servicing that is not authorized by Dell is not covered by your warranty. Read and follow the safety instructions that came with the product.

1. Slip the two securing tabs on the fan interposer board into the two slots on the side of the fan bay. See [Figure C-2](#).
2. Secure the fan interposer board with the two screws.
3. Install the SCSI backplane. See ["Installing the SCSI Backplane."](#)
4. Install the fans. See ["Installing a System Fan"](#) in "Installing System Components."
5. Install the optical drive/diskette drive carrier.  
Slide the drive carrier into its drive bay and press in the release latch. See [Figure 7-3](#).
6. Install the SCSI hard drives in their original locations. See ["Installing a SCSI Hard Drive"](#) in "Installing Drives."
7. Close the system. See ["Closing the System"](#) in "Troubleshooting Your System."
8. Reconnect the system to its electrical outlet and turn the system on, including any attached peripherals.

---

## SCSI Backplane

### Removing the SCSI Backplane

**⚠ CAUTION:** Many repairs may only be done by a certified service technician. You should only perform troubleshooting and simple repairs as authorized in your product documentation, or as directed by the online or telephone service and support team. Damage due to servicing that is not authorized by Dell is not covered by your warranty. Read and follow the safety instructions that came with the product.

1. Turn off the system and attached peripherals, and disconnect the system from the electrical outlet.
2. Open the system. See ["Opening the System"](#) in "Troubleshooting Your System."

**NOTICE:** To prevent damage to the drives and backplane, you must remove the SCSI drives and diskette/optical drive carrier from the system before removing the backplane. You must note the number of each hard drive and temporarily label them before removal so that you can replace them in the same locations.

3. Remove all SCSI hard drives. See "[Removing a SCSI Hard Drive](#)" in "Installing Drives."
4. Remove the optical drive/diskette drive carrier.

To remove the drive carrier, pull the release latch forward, then slide the carrier out of the chassis. See [Figure 7-3](#).

5. Remove the cooling shroud. See "[Removing the Cooling Shroud](#)" in "Installing System Components."
6. Remove the processor filler blanks or heat sinks from processors 2 and 4. See "[Removing a Processor](#)" in "Installing System Components."
7. Disconnect the SCSI, data interface, and power cables from the back of the SCSI backplane.

For improved access, remove the SCSI cable(s) from the clip that is attached to the fan-3 air guard and move the cable(s) away from the backplane; lift up the data interface cable clip from the fan-4 air guard and move the cable away from the backplane. See [Figure C-3](#).

**Figure C-3. Removing and Installing SCSI Backplane Cables**

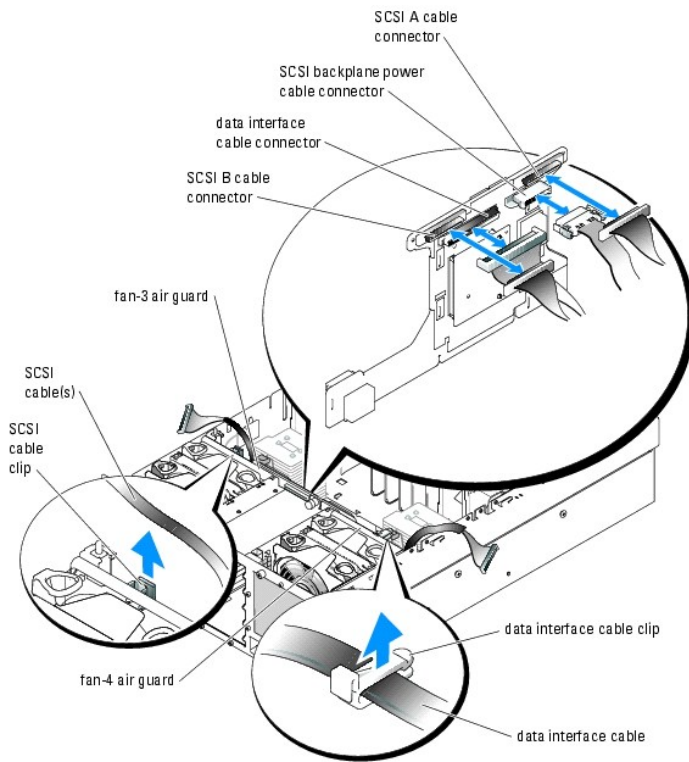

**NOTICE:** When disconnecting the control-panel cable, hold the white pull-tab next to the control-panel cable connector to prevent damage to the SCSI backplane or the cable itself.

8. Disconnect the control-panel cable from the control-panel cable connector on the front of the SCSI backplane. See [Figure C-4](#).
9. Remove the SCSI backplane:
  - a. Pull the spring-loaded blue retention pin away from the front of the backplane, then slide the backplane upward. See [Figure C-4](#).
  - b. When the backplane cannot slide upward any farther, pull the backplane toward the back of the system to remove it from the retention hooks.
  - c. Lift the board out of the system, being careful to avoid damaging components on the face of the board.
  - d. Place the SCSI backplane face down on a work surface.

**Figure C-4. Removing and Installing the SCSI Backplane**

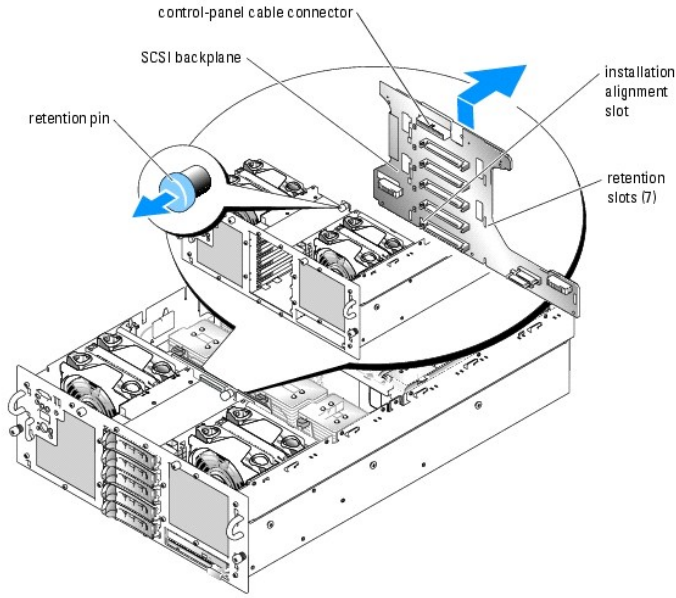

## Installing the SCSI Backplane

**CAUTION:** Many repairs may only be done by a certified service technician. You should only perform troubleshooting and simple repairs as authorized in your product documentation, or as directed by the online or telephone service and support team. Damage due to servicing that is not authorized by Dell is not covered by your warranty. Read and follow the safety instructions that came with the product.

1. Install the SCSI backplane:
  - a. Slowly lower the backplane into the system, being careful to avoid damaging components on the face of the board.
  - b. Align the installation alignment slot on the bottom of the backplane with the alignment pin on the bottom of the chassis. See [Figure C-4](#).
  - c. Slide the retention slots on the backplane over the retention hooks on the chassis.
  - d. Slide the backplane downward until the blue retention pin snaps into place.
2. Connect the SCSI, data interface, and power cables to the back of the SCSI backplane.
 

Secure the SCSI cable(s) in the clip that is attached to the fan-3 air guard; attach the data interface cable clip to the fan-4 air guard to secure the data interface cable. See [Figure C-3](#).
3. Connect the control-panel cable to the front of the SCSI backplane.
4. Install the processor filler blanks or heat sinks on processors 2 and 4. See "[Installing a Processor](#)" in "Installing System Components."
5. Install the SCSI hard drives in their original locations. See "[Installing a SCSI Hard Drive](#)" in "Installing Drives."
6. Install the optical drive/diskette drive carrier.
 

Slide the drive carrier into its drive bay and press in the release latch. See [Figure 7-3](#).
7. Install the cooling shroud. See "[Installing the Cooling Shroud](#)" in "Installing System Components."
8. Close the system. See "[Closing the System](#)" in "Troubleshooting Your System."
9. Reconnect the system to its electrical outlet and turn the system on, including any attached peripherals.

---

## System Board

### Removing the System Board

**⚠ CAUTION:** Many repairs may only be done by a certified service technician. You should only perform troubleshooting and simple repairs as authorized in your product documentation, or as directed by the online or telephone service and support team. Damage due to servicing that is not authorized by Dell is not covered by your warranty. Read and follow the safety instructions that came with the product.

1. Turn off the system and attached peripherals, and disconnect the system from the electrical outlet.
2. Open the system. See "[Opening the System](#)" in "Troubleshooting Your System."

**🔧 NOTICE:** To prevent damage to the drives and backplane, you must remove the SCSI drives and diskette/optical drive carrier from the system before removing the backplane. You must note the number of each hard drive and temporarily label them before removal so that you can replace them in the same locations.

3. Remove all SCSI hard drives. See "[Removing a SCSI Hard Drive](#)" in "Installing Drives."
4. Remove the optical drive/diskette drive carrier.

To remove the drive carrier, pull the release latch forward, then slide the carrier out of the chassis. See [Figure 7-3](#).

5. Remove the cooling shroud. See "[Removing the Cooling Shroud](#)" in "Installing System Components."
6. Remove the heat sinks/processor filler blanks. See "[Removing a Processor](#)" in "Installing System Components."
7. Disconnect the SCSI, data interface, and power cables from the front of the SCSI backplane.

For improved access, remove the SCSI cable(s) from the clip that is attached to the fan-3 air guard and move the cable(s) away from the backplane; lift up the data interface cable clip from the fan-4 air guard and move the cable away from the backplane. See [Figure C-3](#).

8. Remove the memory risers cards/memory filler blanks. Because the system is turned off and the memory riser cards have no power, see "[Removing and Installing a Non-Hot-Pluggable Memory Riser Card](#)" in "Installing System Components."
9. Remove the Fibre Channel module card, if applicable. See "[Removing a Fibre Channel Module Card](#)" in "Installing System Components."
10. Remove all expansion cards. See "[Removing an Expansion Card](#)" in "Installing System Components."
11. Remove the expansion-card insulator:
  - a. Press in the two release tabs and lift up the front of the expansion-card insulator. See [Figure C-5](#).
  - b. Slide the expansion-card insulator toward the front of the chassis.
  - c. Lift the expansion-card insulator out of the chassis.

**Figure C-5. Removing and Installing the Expansion-Card Insulator**

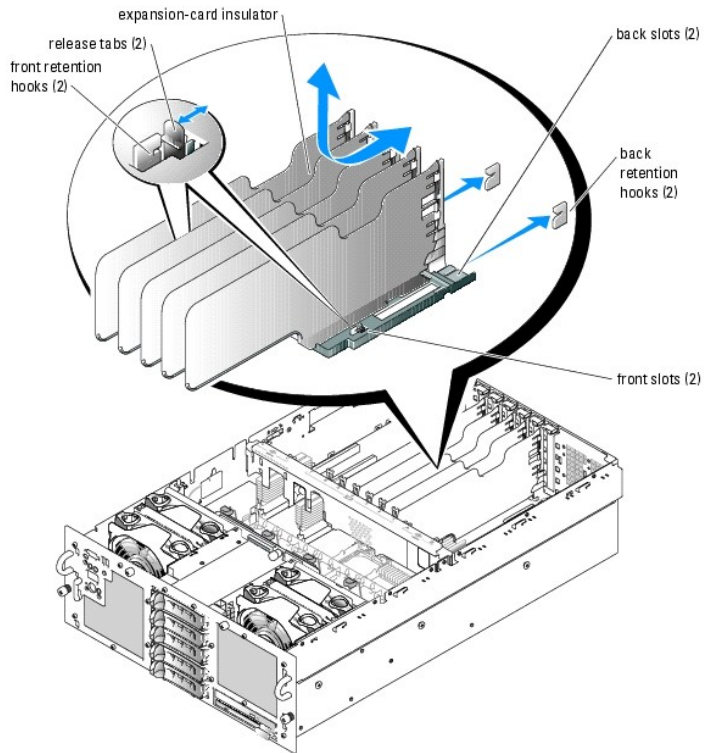

- Place the two slide switches on each side of the chassis in the unlocked position to release the chassis crossbar, then lift up the crossbar and remove it. See [Figure C-6](#).

**Figure C-6. Removing and Installing the Chassis Crossbar**

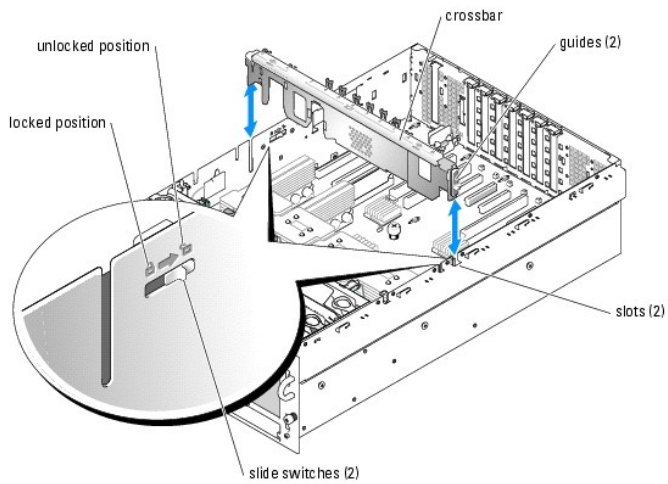

- Disconnect all data interface cables, the chassis intrusion switch cable, and the RAID battery cable (if applicable) from the system board.
- Disconnect the power distribution cable harness from the system board.

The power distribution cable harness and the side of the chassis have Velcro pads to hold the cable harness in place while you remove the system board. Bend the cable harness straight up and secure it to the side of the chassis. See [Figure C-7](#).

**Figure C-7. Securing the Power Distribution Cable Harness**



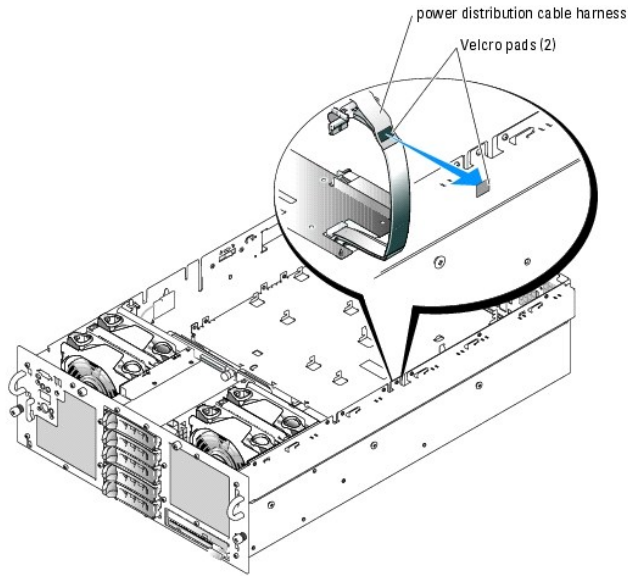

15. Remove the RAID battery compartment:
  - a. Gently pull the RAID battery compartment straight up. See [Figure C-8](#).
  - b. Lift the battery compartment away from the side of the chassis.

**Figure C-8. Removing and Installing the RAID Battery Compartment**

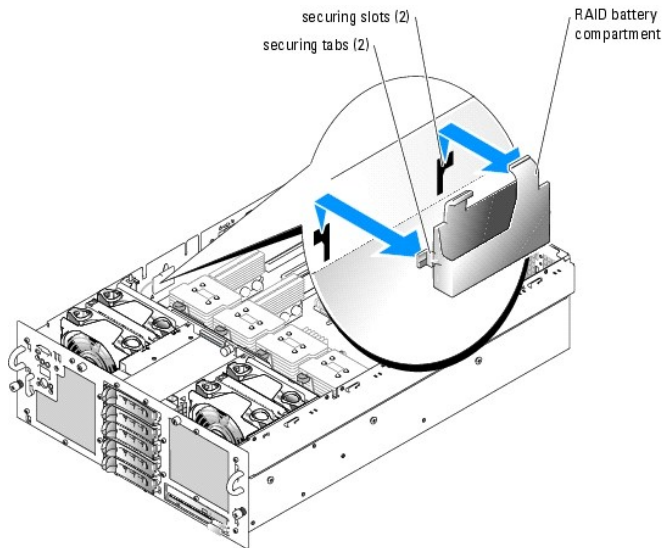

16. Remove the system board:
  - a. Pull up the spring-loaded blue retention pin located in the center of the system board, and then slide the system board toward the front of the chassis until it stops. See [Figure C-9](#).
  - b. Slowly and evenly lift the system board above the retention hooks, ensuring that the system board is clear of all 17 retention hooks, then evenly lift up the left side of the system board. See [Figure C-9](#).
  - c. Lift the system board out of the chassis, left side first.

**Figure C-9. Removing and Installing the System Board**

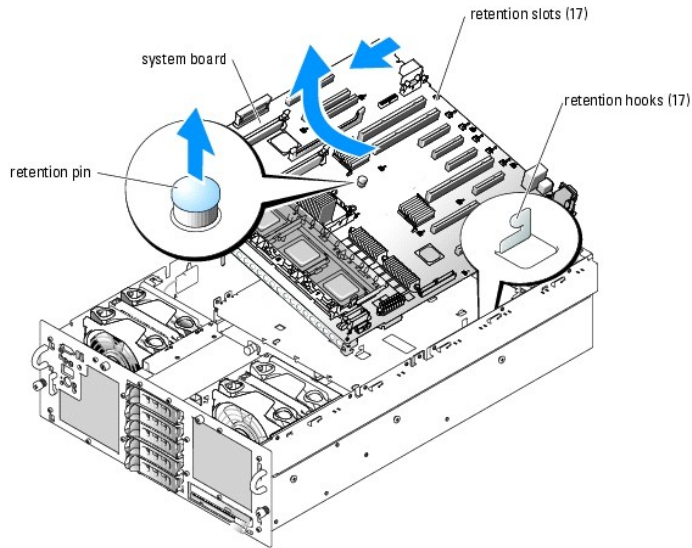

## Installing the System Board

**⚠ CAUTION:** Many repairs may only be done by a certified service technician. You should only perform troubleshooting and simple repairs as authorized in your product documentation, or as directed by the online or telephone service and support team. Damage due to servicing that is not authorized by Dell is not covered by your warranty. Read and follow the safety instructions that came with the product.

1. Transfer the RAID memory and RAID key (if present), processors, VRMs, and jumpers to the new system board. See [Figure A-3](#) in "Jumpers, Switches, and Connectors" for the location of the system board connectors.

**🔧 NOTE:** Do not install the heat sinks/processor filler blanks at this time.

2. Install the new system board:
  - a. Lower the right side of the system board into the chassis.
  - b. Slowly lower the left side of the system board into the chassis.

**🔧 NOTE:** Ensure that the SCSI backplane power cable from the power distribution board does not impede the system board as you lower the system board into the chassis.

- c. Slightly lift up the front of the system board and maneuver the system board to the bottom of the chassis until it lays completely flat.
  - d. Ensure that all 17 retention hooks on the bottom of the chassis are inserted into the retention slots on the system board. See [Figure C-9](#).
  - e. Push the system board toward the back of the chassis until the blue retention pin snaps into place.
3. Install the RAID battery compartment:
  - a. Insert the two securing tabs on the battery compartment into the two securing slots on the side of the chassis. See [Figure C-8](#).
  - b. Press down the battery compartment to secure it.
4. For ease, connect the cables in the order listed below. See [Figure A-3](#) and [Figure A-5](#) in "Jumpers, Switches, and Connectors" for the locations of the connectors on the system board and on the SCSI backplane, respectively.
  - 1 Power distribution harness to the power connectors on the corner of the system board
  - 1 Data interface cable from the system board BKPLN SIG connector to the SCSI backplane interface connector

**🔧 NOTE:** Ensure that you attach the data interface cable and its cable clip to the fan-4 air guard. See [Figure C-3](#).

- 1 SCSI power cable to the SCSI backplane power connector
- 1 RAID battery cable to the system board RAID BAT connector, if applicable
- 1 Chassis intrusion switch cable to the system board intrusion switch connector
- 1 SCSI A data cable from the system board SCSI\_A connector to the SCSI A backplane connector

**🔧 NOTE:** Ensure that you insert the SCSI A cable into the retaining clip on the fan-3 air guard. See [Figure C-3](#).

- I SCSI B data cable from the system board SCSI\_B connector to the SCSI B backplane connector, if applicable

 **NOTE:** Ensure that you insert the SCSI B cable into the retaining clip on the fan-3 air guard. See [Figure C-3](#).

5. Install the heat sinks/processor filler blanks. See "[Installing a Processor](#)" in "Installing System Components."
  6. Install the chassis crossbar:
    - a. Insert the guides on each end of the crossbar into the slots on each side of the chassis. See [Figure C-6](#).
    - b. Slide the crossbar down until the guides are at the bottom of the slots.
    - c. Secure the crossbar by sliding the two slide switches on each side of the chassis to the locked position.
  7. Install the expansion-card insulator:
    - a. Slip the two slots on the back of the insulator into the two back retention hooks that protrude from the bottom of the chassis through the system board. See [Figure C-5](#).
    - b. Align the two slots on the front of the insulator over the two front retention hooks that protrude from the bottom of the chassis through the system board.
    - c. Press in the two release tabs on the slots and secure the insulator onto the retention hooks.
  8. Install all expansion cards. See "[Installing an Expansion Card](#)" in "Installing System Components."
  9. Install the Fibre Channel module card, if applicable. See "[Installing a Fibre Channel Module Card](#)" in "Installing System Components."
  10. Install the memory riser cards/memory filler blanks. Because the system is turned off and the memory riser cards have no power, see "[Removing and Installing a Non-Hot-Pluggable Memory Riser Card](#)" in "Installing System Components."
  11. Install the cooling shroud. See "[Installing the Cooling Shroud](#)" in "Installing System Components."
  12. Install the optical drive/diskette drive carrier.

Slide the drive carrier into its drive bay and press in the release latch. See [Figure 7-3](#).
  13. Install the SCSI hard drives in their original locations. See "[Installing a SCSI Hard Drive](#)" in "Installing Drives."
  14. Close the system. See "[Closing the System](#)" in "Troubleshooting Your System."
  15. Reconnect the system to its electrical outlet and turn the system on, including any attached peripherals.
- 

## Power Distribution Board

### Removing the Power Distribution Board

 **CAUTION:** Many repairs may only be done by a certified service technician. You should only perform troubleshooting and simple repairs as authorized in your product documentation, or as directed by the online or telephone service and support team. Damage due to servicing that is not authorized by Dell is not covered by your warranty. Read and follow the safety instructions that came with the product.

1. Turn off the system and attached peripherals, and disconnect the system from the electrical outlet.
2. Open the system. See "[Opening the System](#)" in "Troubleshooting Your System."
3. Remove the power supplies. See "[Removing a Power Supply](#)" in "Installing System Components."
4. Remove the system board. See "[Removing the System Board](#)."
5. Remove the seven securing screws. See [Figure C-10](#).
6. Lift the power distribution board out of the chassis.

**Figure C-10. Removing and Installing the Power Distribution Board**

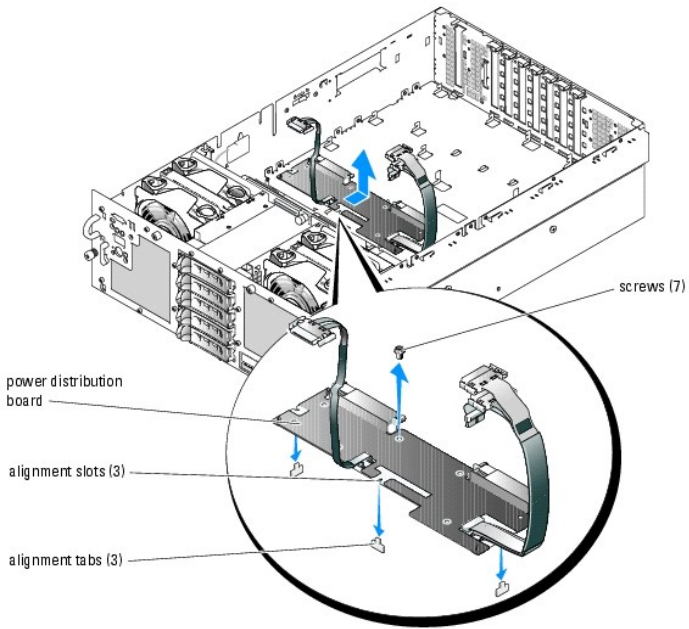

## Installing the Power Distribution Board

**⚠ CAUTION:** Many repairs may only be done by a certified service technician. You should only perform troubleshooting and simple repairs as authorized in your product documentation, or as directed by the online or telephone service and support team. Damage due to servicing that is not authorized by Dell is not covered by your warranty. Read and follow the safety instructions that came with the product.

1. Position the three alignment slots on the power distribution board with the three alignment tabs on the bottom of the chassis. See [Figure C-10](#).
2. Secure the power distribution board with the seven screws.
3. Install the system board. See [step 2](#) through [step 13](#) in "Installing the System Board."
4. Install the power supplies. See "[Installing a Power Supply](#)" in "Installing System Components."
5. Close the system. See "[Closing the System](#)" in "Troubleshooting Your System."
6. Reconnect the system to its electrical outlet and turn the system on, including any attached peripherals.

---

## Chassis Intrusion Switch

### Removing the Chassis Intrusion Switch

**⚠ CAUTION:** Many repairs may only be done by a certified service technician. You should only perform troubleshooting and simple repairs as authorized in your product documentation, or as directed by the online or telephone service and support team. Damage due to servicing that is not authorized by Dell is not covered by your warranty. Read and follow the safety instructions that came with the product.

1. Turn off the system and attached peripherals, and disconnect the system from the electrical outlet.
2. Open the system. See "[Opening the System](#)" in "Troubleshooting Your System."
3. Remove the cooling shroud. See "[Removing the Cooling Shroud](#)" in "Installing System Components."
4. Remove the heat sink or processor filler blank from processor 3. See "[Removing a Processor](#)" in "Installing System Components."
5. Remove the SCSI cables from the clip that is attached to the fan-3 air guard and move the cables to the side. See [Figure C-3](#).

6. Disconnect the intrusion-switch cable from its system board connector. See [Figure C-11](#).
7. Grasp the intrusion switch by its top and bottom areas and slowly and firmly pull the switch out from the intrusion-switch clip.

**Figure C-11. Removing and Installing the Chassis Intrusion Switch**

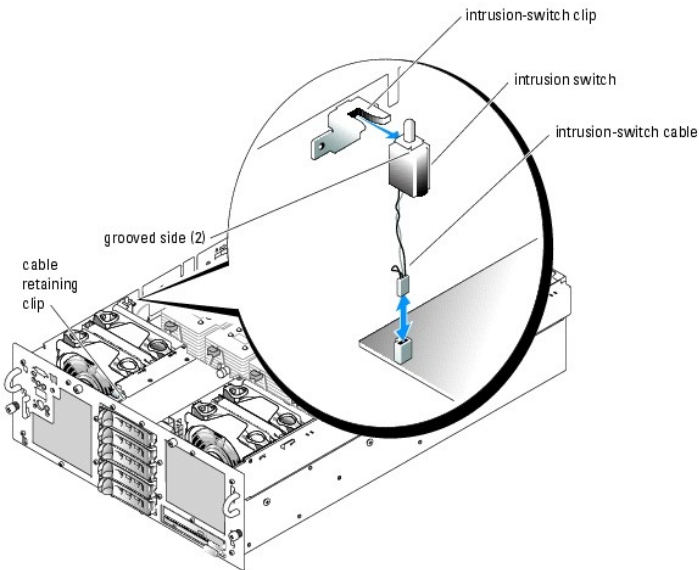

## Installing the Chassis Intrusion Switch

**⚠ CAUTION:** Many repairs may only be done by a certified service technician. You should only perform troubleshooting and simple repairs as authorized in your product documentation, or as directed by the online or telephone service and support team. Damage due to servicing that is not authorized by Dell is not covered by your warranty. Read and follow the safety instructions that came with the product.

1. Connect the intrusion-switch cable to its system board connector. See [Figure C-11](#).
2. Align the two grooved sides of the top of the intrusion switch with the inside of the intrusion-switch clip and then gently, but firmly, press in the switch until it is fully seated. See [Figure C-11](#).
3. Install the heat sink or processor filler blank on processor 3. See "[Installing a Processor](#)" in "Installing System Components."
4. Secure the SCSI cable(s) in the clip that is attached to the fan-3 air guard. See [Figure C-3](#).
5. Install the cooling shroud. See "[Installing the Cooling Shroud](#)" in "Installing System Components."
6. Close the system. See "[Closing the System](#)" in "Troubleshooting Your System."
7. Reconnect the system to its electrical outlet and turn the system on, including any attached peripherals.

## Introduction

### Dell™ PowerEdge™ 6850 Systems Installation and Troubleshooting Guide

#### [Other Documents You May Need](#)

Your system includes the following significant service and upgrade features:

- 1 2x5-character LCD display for error messaging at system startup
- 1 Baseboard Management Controller (BMC), which monitors temperatures and voltages throughout the system and notifies you if the system overheats, if a system cooling fan malfunctions, or if a power supply fails
- 1 Hot-pluggable cooling fans
- 1 Hot-pluggable memory riser cards
- 1 System diagnostics, which checks for hardware problems (if the system can boot)

System upgrade options are offered, including:

- 1 Additional Intel® Xeon™ processors
  - 1 Additional system memory
  - 1 A variety of hot-pluggable PCI-X and PCIe expansion-card options (including RAID controller cards)
  - 1 Remote access controller (RAC) for remote systems management
  - 1 An integrated RAID controller that can be activated with an additional memory module, key, and battery
  - 1 Integrated Fibre Channel module
  - 1 External SCSI connection
  - 1 IDE optical drive
  - 1 Diskette drive
  - 1 Additional hard drives
- 

## Other Documents You May Need

 The *Product Information Guide* provides important safety and regulatory information. Warranty information may be included within this document or as a separate document.

- 1 The *Rack Installation Guide* or *Rack Installation Instructions* included with your rack solution describes how to install your system into a rack.
- 1 The *Getting Started Guide* provides an overview of initially setting up your system.
- 1 The *User's Guide* provides information about system features and technical specifications.
- 1 Systems management software documentation describes the features, requirements, installation, and basic operation of the software.
- 1 Operating system documentation describes how to install (if necessary), configure, and use the operating system software.
- 1 Documentation for any components you purchased separately provides information to configure and install these options.
- 1 Updates are sometimes included with the system to describe changes to the system, software, and/or documentation.

 **NOTE:** Always read the updates first because they often supersede information in other documents.

- 1 Release notes or readme files may be included to provide last-minute updates to the system or documentation or advanced technical reference material intended for experienced users or technicians.
-

[Back to Contents Page](#)

## Indicators, Messages, and Codes

Dell™ PowerEdge™ 6850 Systems Installation and Troubleshooting Guide

- [Front-Panel Indicators and Features](#)
- [Back-Panel Features and Indicators](#)
- [SCSI Hard-Drive Indicator Codes](#)
- [Power Indicator Codes](#)
- [NIC Indicator Codes](#)
- [LCD Status Messages](#)
- [System Messages](#)
- [System Beep Codes](#)
- [Warning Messages](#)
- [Diagnostic Messages](#)
- [Alert Messages](#)
- [Baseboard Management Controller Messages](#)

The system, applications, and operating systems can identify problems and alert you to them. Any of the following can indicate when the system is not operating properly:

- 1 System indicators
- 1 System messages
- 1 Beep codes
- 1 Warning messages
- 1 Diagnostics messages
- 1 Alert messages

This section describes each type of message, lists the possible causes, and provides steps to resolve any problems indicated by a message. The system indicators and features are illustrated in this section.

---

## Front-Panel Indicators and Features

### System Status Indicators

The optional locking system bezel incorporates a system status indicator. The system status indicator lights blue when the system is operating correctly and lights amber when the system needs attention due to a problem with power supplies, fans, system temperature, or hard drives.

[Table 2-1](#) lists the system's indicator patterns. Different patterns are displayed as events occur in the system.

**Table 2-1. System Status Indicator Patterns**

Blue indicator	Amber indicator	Description
Off	Off	Power is not available to the system.
Off	Blinking	The system has detected an error. See " <a href="#">System Messages</a> " and "Troubleshooting Your System" for more information.
On	Off	Power is on, and the system is operational.
Blinking	Off	The indicator has been activated to identify the system in a rack.



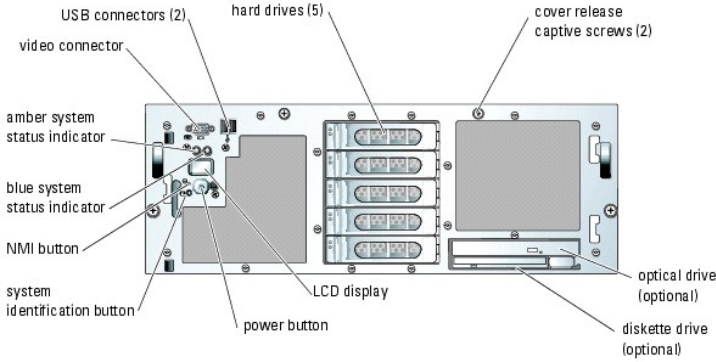

**NOTE:** The blue indicator always blinks during system identification, even if an error has been detected. After the system is identified, the blue indicator stops blinking and the amber indicator resumes blinking.

[Figure 2-1](#) shows the controls, indicators, and connectors located behind the optional bezel on the system's front panel. [Table 2-2](#) describes the front-panel features.

**Figure 2-1. Front-Panel Features and Indicators**



**Table 2-2. Front-Panel LED Indicators, Buttons, and Connectors**

Indicator, Button, or Connector	Icon	Description
Blue system status indicator		Does not operate when the bezel is removed. The LCD display indicates the status.
Amber system status indicator		Does not operate when the bezel is removed. The LCD display indicates the status.
LCD display		Provides system ID, status information, and system error messages.  The LCD display lights during normal system operation. Both the systems management software and the identification buttons located on the front and back of the system can cause the LCD to flash blue to identify a particular system.  The LCD display lights amber when the system needs attention due to a problem with power supplies, fans, system temperature, or hard drives. See " <a href="#">LCD Status Messages</a> " and <a href="#">Table 2-7</a> for more information about the messages.  <b>NOTE:</b> If the system is connected to AC power and an error has been detected, the LCD display flashes amber regardless of whether the system has been powered on.
Power-on indicator, power button		The power-on indicator lights when the system power is on. The power-on indicator blinks when power is available to the system, but the system is not powered on.  The power button controls the DC power supply output to the system.  <b>NOTE:</b> If you turn off the system using the power button and the system is running an ACPI-compliant operating system, the system performs a graceful shutdown before the power is turned off. If the system is not running an ACPI-compliant operating system, the power is turned off immediately after the power button is pressed.
System identification button		The identification buttons on the front and back panels can be used to locate a particular system within a rack. When one of these buttons is pushed, the blue system status indicator on the front and back blinks until one of the buttons is pushed again.
USB connectors		Connects USB 2.0-compliant devices to the system.
NMI button		Used to troubleshoot software and device driver errors when using certain operating systems. This button can be pressed using the end of a paper clip.  Use this button only if directed to do so by qualified support personnel or by the operating system's documentation.
Video connector		Connects a monitor to the system.

## Back-Panel Features and Indicators

[Figure 2-2](#) shows the controls, indicators, and connectors located on the system's back panel.

**Figure 2-2. Back-Panel Features and Indicators**



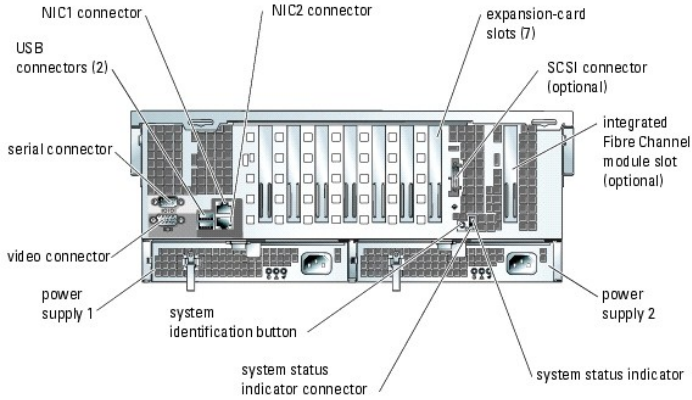

## SCSI Hard-Drive Indicator Codes

If RAID is activated, two indicators on each of the hard-drive carriers provide information on the status of the SCSI hard drives. RAID can be enabled either by using ROMB on the system board or by using a RAID card connected to the system board. See [Figure 2-3](#) and [Table 2-3](#). The SCSI backplane firmware controls the drive power-on/fault indicator.

**Figure 2-3. SCSI Hard-Drive Indicators**

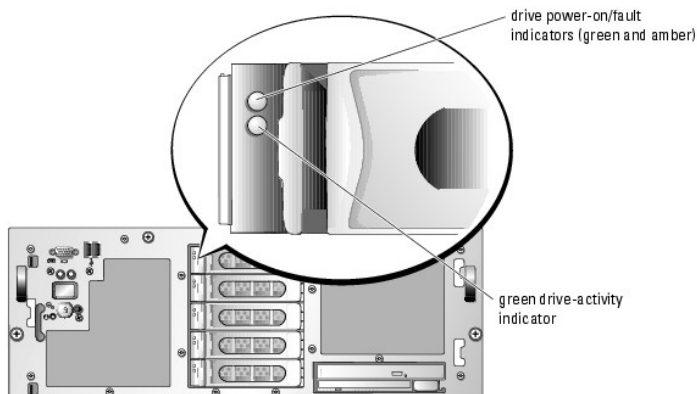

[Table 2-3](#) lists the drive indicator patterns. Different patterns are displayed as drive events occur in the system. For example, if a hard drive fails, the "drive failed" pattern appears. After the drive is selected for removal, the "drive being prepared for removal" pattern appears, followed by the "drive ready for insertion or removal" pattern. After the replacement drive is installed, the "drive being prepared for operation" pattern appears, followed by the "drive online" pattern.

**NOTE:** If a RAID controller is not present, the green power-on/fault indicator is on if power is available to the drive. The drive-activity indicator also blinks when the drive is being accessed.

**Table 2-3. Hard-Drive Indicator Patterns**

Condition	Indicator Pattern
Identify drive	The green power-on/fault indicator blinks four times per second.
Drive being prepared for removal	The green power-on/fault indicator blinks two times per second.
Drive ready for insertion or removal	Both drive indicators are off.
Drive being prepared for operation	The green power-on/fault indicator is on.
Drive predicted failure	The power-on/fault indicator slowly blinks green, amber, and off.
Drive failed	The amber power-on/fault indicator blinks four times per second.
Drive rebuilding	The green power-on/fault indicator blinks slowly.
Drive online	The green power-on/fault indicator is on.

## Power Indicator Codes

The power button on the front panel controls the power input to the system's power supplies. The power indicator can provide information on power status (see [Figure 2-1](#)). [Table 2-4](#) lists the power button indicator codes.

**Table 2-4. Power Button Indicators**

Indicator	Function
On	Indicates that power is supplied to the system and the system is operational.
Off	Indicates that no power is supplied to the system.
Blinking	Indicates that power is supplied to the system, but the system is in a standby state. For information on standby states, see your operating system documentation.

The indicators on the power supplies show whether power is present or whether a power fault has occurred (see [Figure 2-4](#)).

**NOTE:** The 1470-W power supplies require 200–240 V to operate. If they are plugged into 110-V electrical outlets, the power supplies do not power up.

**Table 2-5. Power Supply Indicators**

Indicator	Function
Power supply status	Green indicates that the power supply is operational.
Power supply fault	Amber indicates a problem with the power supply.
AC line status	Green indicates that a valid AC source is connected to the power supply.

**Figure 2-4. Power Supply Indicators**

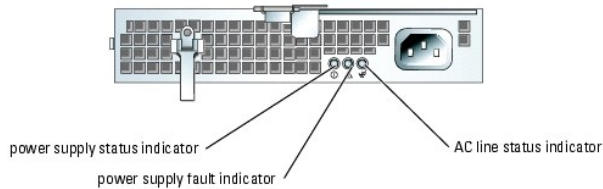

## NIC Indicator Codes

**Figure 2-5. NIC Indicators**

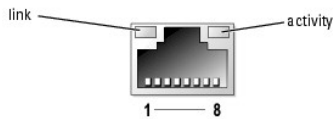

**Table 2-6. NIC Indicators**

Link indicator	Activity indicator	Description
Off	Off	The NIC is not connected to the network or the NIC is disabled in the System Setup screen. See "Using the System Setup Program" in the <i>User's Guide</i> .
Green	Off	Indicates that the network adapter is connected to a valid link partner on the network, but data is not currently being sent or received.
Green	Blinking amber	Indicates that network data is being sent or received.

## LCD Status Messages

The system status indicator can signify when the system is operating correctly or when the system needs attention. When the system status indicator signifies an error condition, remove the optional bezel to see further information provided by the status LCD.

The LCD can display two lines of alphanumeric characters. The display codes are presented in two color combinations:

- 1 Blue background — Information only; no action is required.
- 1 Amber background — The system needs attention.

[Table 2-7](#) lists the LCD status messages that can occur and the probable cause for each message. The LCD messages refer to events recorded in the system event log (SEL). For information on the SEL and configuring system management settings, see the systems management software documentation.

**⚠ CAUTION:** Many repairs may only be done by a certified service technician. You should only perform troubleshooting and simple repairs as authorized in your product documentation, or as directed by the online or telephone service and support team. Damage due to servicing that is not authorized by Dell is not covered by your warranty. Read and follow the safety instructions that came with the product.

**Table 2-7. LCD Status Messages**

Line 1 Message	Line 2 Message	Causes	Corrective Actions
<i>SYSTEM ID</i>	<i>SYSTEM NAME</i>	<p><i>SYSTEM ID</i> is a unique name, five characters or less, defined by the user.</p> <p><i>SYSTEM NAME</i> is a unique name, 16 characters or less, defined by the user.</p> <p>The system ID and name display under the following conditions:</p> <ul style="list-style-type: none"> <li>1 The system is powered on.</li> <li>1 The power is off and active POST errors are displayed.</li> </ul>	<p>This message is for information only.</p> <p>You can change the system ID and name in the System Setup program. See your <i>User's Guide</i> for instructions.</p>
E0000	OVRFLW CHECK LOG	<p>LCD overflow message.</p> <p>A maximum of three error messages can display sequentially on the LCD. The fourth message displays as the standard overflow message.</p>	Check the SEL for details on the events.
E0119	TEMP AMBIENT TEMP BMC	Ambient system temperature is out of acceptable range.	See " <a href="#">Troubleshooting System Cooling Problems</a> " in "Troubleshooting Your System."
E0212	VOLT PG <i>n</i>	System power supply is out of acceptable voltage range; faulty or improperly installed power supply.	See " <a href="#">Troubleshooting Power Supplies</a> " in "Troubleshooting Your System."
E0212	VOLT BATT ROMB	Faulty RAID battery.	Replace the RAID battery. See " <a href="#">Activating the Optional Integrated RAID Controller</a> " in "Installing Drives."
E0212	VOLT BATT CMOS	Faulty system battery.	See " <a href="#">Troubleshooting the System Battery</a> " in "Troubleshooting Your System." If the problem persists, see " <a href="#">Getting Help</a> ."
E0412	RPM FAN <i>n</i> FAN REDUNDANCY LOST	Specified cooling fan is faulty, improperly installed, or missing.	See " <a href="#">Troubleshooting System Cooling Problems</a> " in "Troubleshooting Your System."
E0780	PROC <i>n</i> PRESENCE	Microprocessor is not installed in socket <i>n</i> .	Install a microprocessor in socket <i>n</i> . See " <a href="#">Installing a Processor</a> " in "Installing System Components."
E07F0	PROC <i>n</i> IERR	Faulty or improperly installed microprocessor.	See " <a href="#">Troubleshooting the Microprocessors</a> " in "Troubleshooting Your System."
E07FA	PROC <i>n</i> THERMTRIP	Specified microprocessor is out of acceptable temperature range and has halted operation.	<p>See "<a href="#">Troubleshooting System Cooling Problems</a>" in "Troubleshooting Your System." If the problem persists, ensure that the microprocessor heat sinks are properly installed. See "<a href="#">Removing a Processor</a>" in "Installing System Components."</p> <p><b>NOTE:</b> The LCD continues to display this message until the system's power cord is disconnected and reconnected to the AC power source, or the SEL is cleared using either Server Assistant or the BMC Management Utility. See the <i>Dell OpenManage Baseboard Management Controller User's Guide</i> for information about these utilities.</p>
E0876	PS <i>n</i> MISSING PS <i>n</i> STATUS	No power available from the specified power supply; specified power supply is improperly installed or faulty.	See " <a href="#">Troubleshooting Power Supplies</a> " in "Troubleshooting Your System."
E0876	PS <i>n</i> PREDICTIVE	Power supply voltage is out of acceptable range; specified power supply is improperly installed or faulty.	See " <a href="#">Troubleshooting Power Supplies</a> " in "Troubleshooting Your System."
E0876	PS <i>n</i> AC LOST PS <i>n</i> AC RANGE	Power source for specified power supply is unavailable, or out of acceptable range.	Check the AC power source for the specified power supply.
E0D76	BP DRIVE <i>n</i>  1x2 DRIVE FAIL <i>n</i>  SCSI CONNECTOR	Faulty or improperly installed hard drive or RAID controller.	See " <a href="#">Troubleshooting SCSI Hard Drives</a> " " <a href="#">Troubleshooting a RAID Controller Card</a> ," and " <a href="#">Troubleshooting the Integrated RAID Controller</a> " in "Troubleshooting Your System."

EB107	PROC BUS ERR PROC INIT ERR PROC PROTOCOL ERR	Faulty or improperly installed microprocessor or system board.	See " <a href="#">Troubleshooting the Microprocessors</a> " in "Troubleshooting Your System." If the problem persists, see " <a href="#">Getting Help</a> ."
EB107	PCIe FATAL ERR CHIPSET ERR	Faulty or improperly installed PCIe card. Faulty system board.	Remove and reseat the PCIe expansion cards. If the problem persists, see " <a href="#">Troubleshooting Expansion Cards</a> " in "Troubleshooting Your System."  If the problem persists, the system board is faulty. See " <a href="#">Getting Help</a> ."
EB107	MEMORY MIRRORED	Memory mirroring enabled.	Information only.
EB107	MEMORY SPARED	Memory spare bank enabled.	Information only.
EFFF2	ROMB PRESENCE	Integrated RAID controller is activated.	Information only.
IB110	SBE LOG DISABLED LOGGING DISABLED		Information only.
IS000	INTRUSION	System cover has been removed.	Information only
<b>NOTE:</b> For the full name of an abbreviation or acronym used in this table, see the "Glossary" in your <i>User's Guide</i> .			

## System Messages

System messages appear on the screen during system boot to notify you of a possible problem with the system. [Table 2-8](#) lists the system messages that can occur and the probable cause and corrective action for each message.

 **NOTE:** If you receive a system message that is not listed in [Table 2-8](#), check the documentation for the application that is running when the message appears or the operating system's documentation for an explanation of the message and recommended action.

 **CAUTION:** Many repairs may only be done by a certified service technician. You should only perform troubleshooting and simple repairs as authorized in your product documentation, or as directed by the online or telephone service and support team. Damage due to servicing that is not authorized by Dell is not covered by your warranty. Read and follow the safety instructions that came with the product.

**Table 2-8. System Messages**

Message	Causes	Corrective Actions
Alert! Redundant memory disabled! Memory configuration does not support redundant memory.	The current memory configuration does not support redundant memory.	Install a memory configuration that supports redundant memory (spare bank feature). See " <a href="#">General Memory Module Installation Guidelines</a> " in "Installing System Components."  Disable the <b>Redundant Memory</b> option in the System Setup program. See "Using the System Setup Program" in your <i>User's Guide</i> .
Attempting to update Remote Configuration. Please wait....	Remote Configuration is in progress.	Wait until the process is complete.
BIOS Update Attempt Failed	BIOS remote update failed.	Retry update.
Caution! NVRAM_CLR jumper is installed on system board.	NVRAM_CLR jumper is installed.	Remove the NVRAM_CLR jumper. See <a href="#">Figure A-2</a> for the jumper location.
CD-ROM drive not found	Improperly connected or missing CD drive.	If no optical drive is installed, disable the IDE controller. See "Using the System Setup Program" in your <i>User's Guide</i> .  If an optical drive is installed, see " <a href="#">Troubleshooting an Optical Drive</a> " in "Troubleshooting Your System."
CPUs with different cache sizes detected.	Mismatched processors are installed.	Install a correct version of the microprocessor so that both microprocessors have the same cache size. See " <a href="#">Processor</a> " in "Installing System Components."
Decreasing available memory	Faulty or improperly installed memory modules.	Ensure that all memory modules are properly installed. See " <a href="#">Troubleshooting System Memory</a> " in "Troubleshooting Your System."
Diskette drive 0 seek failure	Incorrect configuration settings in System Setup program.  Faulty or improperly installed diskette, loose diskette drive or optical drive interface cable, or loose power cable.	Run the System Setup program to correct the settings. See "Using the System Setup Program" in your <i>User's Guide</i> .  Replace the diskette. Ensure that the diskette drive and optical drive cables are properly connected. See " <a href="#">Troubleshooting a Diskette Drive</a> " and " <a href="#">Troubleshooting an Optical Drive</a> " in "Troubleshooting Your System."
Diskette read failure	Faulty or improperly inserted diskette.	Replace the diskette.
Diskette subsystem reset failed	Faulty diskette drive or optical drive controller.	Ensure that the diskette drive and optical drive cables are properly connected. See " <a href="#">Troubleshooting a Diskette Drive</a> " and " <a href="#">Troubleshooting an Optical Drive</a> " in "Troubleshooting Your System." If the problem persists, see " <a href="#">Getting Help</a> ."

Drive not ready	Diskette missing or improperly inserted in diskette drive.	Reinsert or replace the diskette.
Embedded RAID error	An error has been generated by the firmware used by the optional integrated RAID controller.	Update the RAID firmware using the Dell Support website at <a href="http://support.dell.com">support.dell.com</a> .
Embedded RAID firmware is not present	The firmware used by the optional integrated RAID controller is not responding to system requests.	Restore the RAID firmware using the Dell Support website at <a href="http://support.dell.com">support.dell.com</a> .
Error: Incorrect memory configuration. Ensure memory in slots DIMM_1A and DIMM_1B, DIMM_2A and DIMM_2B on each memory card match identically in size, speed, and rank.	One or more unmatched pairs of memory modules are detected	Ensure that the memory modules are installed in matched pairs. See " <a href="#">General Memory Module Installation Guidelines</a> " in "Installing System Components."
Error: Incorrect memory configuration. When mixing Dual and Single Rank memory on the same memory card, Dual Rank DIMMs must be in slots DIMM_1A and DIMM_1B, and Single Rank DIMMs must be in slots DIMM_2A and DIMM_2B.	Dual-rank memory modules are installed in slots DIMM_2A and DIMM_2B.	Ensure that only single-rank memory modules are installed in slots DIMM_2A and DIMM_2B. See " <a href="#">General Memory Module Installation Guidelines</a> " in "Installing System Components."
Error: Incorrect memory configuration. Memory cards with DIMMs must be populated in order: MEM A, MEM B, MEM C, then MEM D.	Memory riser cards must be installed in consecutive order.	Move memory riser cards so they are installed in order. See " <a href="#">System Memory</a> " in "Installing System Components."
Error: More than one RAC detected, system halted.	Two RACs are installed, or faulty or improperly installed RAC.	Ensure that only one RAC is installed. Ensure that the RAC is properly installed. See " <a href="#">Troubleshooting Expansion Cards</a> " in "Troubleshooting Your System."
Error: Remote Access Card initialization failure.	Faulty or improperly installed RAC.	Ensure that the RAC is properly installed. See " <a href="#">Troubleshooting Expansion Cards</a> " in "Troubleshooting Your System."
Error 8602: Auxiliary device failure. Verify that the keyboard and mouse are securely attached to correct connectors.	Loose or improperly connected mouse or keyboard cable; faulty mouse or keyboard.	Replace the mouse. If the problem persists, replace the keyboard.
Gate A20 failure	Faulty keyboard controller (faulty system board).	See " <a href="#">Getting Help</a> ."
General failure	Operating system corrupted or improperly installed.	Reinstall the operating system.
Keyboard controller failure	Faulty keyboard controller (faulty system board).	See " <a href="#">Getting Help</a> "
Keyboard data line failure	Loose or improperly connected keyboard cable; faulty keyboard; faulty keyboard controller.	Ensure that the keyboard is properly connected. If the problem persists, replace the keyboard. If the problem persists, see " <a href="#">Getting Help</a> ."
Keyboard failure		
Keyboard stuck key failure		
Keyboard fuse has failed.	Keyboard fuse has failed.	Replace the keyboard. Faulty system board. See " <a href="#">Getting Help</a> ."
Manufacturing mode detected	System is incorrectly configured.	After the message appears during system boot, press <Alt><F> to turn off manufacturing mode.
Memory address line failure at <i>address</i> , read value expecting value  Memory double word logic failure at <i>address</i> , read value expecting value  Memory odd/even logic failure at <i>start address</i> to <i>end address</i>  Memory write/read failure at <i>address</i> , read value expecting value	Faulty or improperly installed memory modules, or faulty system board.	Ensure that all memory modules are properly installed. See " <a href="#">Troubleshooting System Memory</a> " in "Troubleshooting Your System." If the problem persists, see " <a href="#">Getting Help</a> ."
Memory mirroring enabled	Memory mirroring enabled	You can enable memory mirroring using the System Setup program if the memory is configured to support mirroring. For more information, see " <a href="#">General Memory Module Installation Guidelines</a> " in "Installing System Components," and "Using the System Setup Program" in your <i>User's Guide</i> .
Memory tests terminated by keystroke	The spacebar was pressed during POST to terminate the memory test.	Information only.
No boot device available	Faulty or missing diskette drive, optical drive, or hard drive.	Check the <b>Integrated Devices</b> configuration settings in the System Setup program. See "Using the System Setup Program" in your <i>User's Guide</i> . Ensure that either <b>SCSI Controller</b> , <b>Diskette Controller</b> , or <b>IDE CD-ROM Controller</b> is enabled. If the system is booting from a SCSI controller, ensure that the controller is properly connected. If the problem persists, replace the drive. See " <a href="#">Installing Drives</a> ."
No boot sector on hard-disk drive	An operating system is not on the hard drive.	Check the hard-drive configuration settings in the System Setup program. See "Using the System Setup Program" in your <i>User's Guide</i> .
No timer tick interrupt	Faulty system board.	See " <a href="#">Getting Help</a> ."
Not a boot diskette	Not a bootable diskette.	Use a bootable diskette.
PCI BIOS failed to install	Loose cables to expansion card(s); faulty or improperly	Ensure that all appropriate cables are securely connected to the expansion cards. See " <a href="#">Troubleshooting Expansion Cards</a> ," in

	installed expansion card.	"Troubleshooting Your System."
PCIe Degraded Link Width Error: Embedded Bus# <i>nn</i> /Dev# <i>nn</i> /Func <i>n</i>  Expected Link Width is <i>n</i>  Actual Link Width is <i>n</i>	Faulty or improperly installed PCIe card.	Reseat the PCIe cards. See " <a href="#">Expansion Cards</a> ." If the problem persists, see " <a href="#">Getting Help</a> ."
PCIe Degraded Link Width Error: Slot <i>n</i>  Expected Link Width is <i>n</i>  Actual Link Width is <i>n</i>	Faulty or improperly installed PCIe card in the specified slot number.	Reseat the PCIe card in the specified slot number. See " <a href="#">Expansion Cards</a> ." If the problem persists, see " <a href="#">Getting Help</a> ."
PCIe Training Error: Embedded Bus# <i>nn</i> /Dev# <i>nn</i> /Func <i>n</i>	Faulty or improperly installed PCIe card.	Reseat the PCIe cards. See " <a href="#">Expansion Cards</a> ." If the problem persists, see " <a href="#">Getting Help</a> ."
PCIe Training Error: Slot <i>n</i>	Faulty or improperly installed PCIe card in the specified slot number.	Reseat the PCIe card in the specified slot number. See " <a href="#">Expansion Cards</a> ." If the problem persists, see " <a href="#">Getting Help</a> ."
Plug & Play Configuration Error	Error encountered in initializing PCI device; faulty system board.	Install the NVRAM_CLR jumper and reboot the system. See <a href="#">Figure A-2</a> for jumper location. Check for a BIOS update. If the problem persists, see " <a href="#">Troubleshooting Expansion Cards</a> " in "Troubleshooting Your System." If the problem persists, see " <a href="#">Getting Help</a> ."
Read fault  Requested sector not found	Faulty diskette, diskette drive, optical drive, or hard drive.	Replace the diskette. Ensure that the diskette, optical, and hard-drive cables are properly connected. See " <a href="#">Troubleshooting a Diskette Drive</a> ," " <a href="#">Troubleshooting an Optical Drive</a> ," or " <a href="#">Troubleshooting SCSI Hard Drives</a> " in "Troubleshooting Your System" for the appropriate drive(s) installed in your system.
Remote Configuration update attempt failed	System could not implement Remote Configuration request.	Retry Remote Configuration.
ROM bad checksum = <i>address</i>	Faulty or improperly installed expansion card.	Remove and reseat the expansion cards. See " <a href="#">Troubleshooting Expansion Cards</a> " in "Troubleshooting Your System."
Sector not found  Seek error  Seek operation failed	Faulty diskette or hard drive.	Replace the diskette. If the problem persists, see " <a href="#">Troubleshooting SCSI Hard Drives</a> " in "Troubleshooting Your System" for the appropriate drive installed in your system.
Shutdown failure	Shutdown test failure.	Ensure that all memory modules are properly installed. See " <a href="#">Troubleshooting System Memory</a> " in "Troubleshooting Your System." If the problem persists, see " <a href="#">Getting Help</a> ."
Spare bank enabled	Memory spare bank enabled.	You can enable memory spare bank using the System Setup program if the memory is configured to support this feature. For more information, see " <a href="#">General Memory Module Installation Guidelines</a> " in "Installing System Components," and "Using the System Setup Program" in your <i>User's Guide</i> .
The amount of system memory has changed.	Faulty memory module.  Information only, if you have changed the memory configuration.	See " <a href="#">Troubleshooting System Memory</a> " in "Troubleshooting Your System." If the problem persists, see " <a href="#">Getting Help</a> ."
Time-of-day clock stopped	Faulty battery; faulty system board.	See " <a href="#">Troubleshooting the System Battery</a> " in "Troubleshooting Your System." If the problem persists, see " <a href="#">Getting Help</a> ."
Time-of-day not set - please run SETUP program	Incorrect <b>Time</b> or <b>Date</b> settings; faulty system battery.	Check the <b>Time</b> and <b>Date</b> settings. See "Using the System Setup Program" in your <i>User's Guide</i> . If the problem persists, see " <a href="#">Troubleshooting the System Battery</a> " in "Troubleshooting Your System."
Timer chip counter 2 failed	Faulty system board.	See " <a href="#">Getting Help</a> ."
Unsupported RAID key detected.	A RAID key intended for use with another system is installed.	Replace the RAID key.
Unexpected interrupt in protected mode	Faulty or improperly installed memory modules or faulty system board.	Ensure that all memory modules are properly installed. See " <a href="#">General Memory Module Installation Guidelines</a> " in "Installing System Components." If the problem persists, see " <a href="#">Troubleshooting System Memory</a> " in "Troubleshooting Your System." If the problem persists, see " <a href="#">Getting Help</a> ."
Unsupported CPU combination	Mismatched processors are installed.  Processor is not supported by the system.	Replace a microprocessor so that both microprocessors match. See " <a href="#">Processor</a> " in "Installing System Components."  Check for a BIOS update using the Dell Support website at <a href="#">support.dell.com</a> . If the problem persists, install a supported processor. See " <a href="#">Processor</a> " in "Installing System Components."
Unsupported CPU stepping detected	Processor is not supported by the system.	Check for a BIOS update using the Dell Support website at <a href="#">support.dell.com</a> . If the problem persists, install a supported processor. See " <a href="#">Processor</a> " in "Installing System Components."
Utility partition not available	<F10> key was pressed during POST, but no utility partition exists on the boot hard drive.	Create a utility partition on the boot hard drive. See "Using the Dell OpenManage Server Assistant CD" in your <i>User's Guide</i> .
Warning: Detected mode change from RAID to SCSI <i>x</i> of the embedded RAID subsystem.	Type of controller has changed from optional RAID to SCSI since previous system boot.	Back up information on the hard drives before changing the type of controller used with the drives.
Warning: Detected mode change from SCSI to RAID	Type of controller has	Back up information on the hard drives before changing the type of

x of the embedded RAID subsystem.	changed from SCSI to optional RAID since previous system boot.	controller used with the drives.
Warning! No microcode update loaded for processor n	Unsupported processor.	Update the BIOS firmware using the Dell Support website at <a href="http://support.dell.com">support.dell.com</a> .
Write fault Write fault on selected drive	Faulty diskette, diskette drive, optical drive, hard drive.	Replace the diskette. Ensure that the diskette drive, optical drive, and hard-drive cables are properly connected. See " <a href="#">Troubleshooting a Diskette Drive</a> ," " <a href="#">Troubleshooting an Optical Drive</a> ," or " <a href="#">Troubleshooting SCSI Hard Drives</a> " in "Troubleshooting Your System" for the appropriate drive(s) installed in your system.

## System Beep Codes

If an error that cannot be reported on the screen occurs during POST, the system may emit a series of beeps that identifies the problem.

 **NOTE:** If the system boots without a keyboard, mouse, or monitor attached, the system does not issue beep codes related to those peripherals.

If a beep code is emitted, write down the series of beeps and then look it up in [Table 2-9](#). If you are unable to resolve the problem by looking up the meaning of the beep code, use system diagnostics to identify the possible cause. See "[Running the System Diagnostics](#)" for more information. If you are still unable to resolve the problem, see "[Getting Help](#)."

 **CAUTION:** Many repairs may only be done by a certified service technician. You should only perform troubleshooting and simple repairs as authorized in your product documentation, or as directed by the online or telephone service and support team. Damage due to servicing that is not authorized by Dell is not covered by your warranty. Read and follow the safety instructions that came with the product.

**Table 2-9. System Beep Codes**

Code	Cause	Corrective Action
1-1-2	CPU register test failure	See " <a href="#">Troubleshooting the Microprocessors</a> " in "Troubleshooting Your System."
1-1-3	CMOS write/read failure; faulty system board	Faulty system board. See " <a href="#">Getting Help</a> ."
1-1-4	BIOS error	Reflash the BIOS.
1-2-1	Programmable interval-timer failure; faulty system board	Faulty system board. See " <a href="#">Getting Help</a> ."
1-2-2	DMA initialization failure	See " <a href="#">Troubleshooting System Memory</a> " in "Troubleshooting Your System."
1-2-3	DMA page register write/read failure	
1-3-1	Main-memory refresh verification failure	
1-3-2	No memory installed	
1-3-3	Chip or data line failure in the first 64 KB of main memory	
1-3-4	Odd/even logic failure in the first 64 KB of main memory	
1-4-1	Address line failure in the first 64 KB of main memory	
1-4-2	Parity failure in the first 64 KB of main memory	
1-4-3	Fail-safe timer test failure	
1-4-4	Software NMI port test failure	
2-1-1 through 2-4-4	Bit failure in the first 64 KB of main memory	
3-1-1	Slave DMA-register failure	Faulty system board. See " <a href="#">Getting Help</a> ."
3-1-2	Master DMA-register failure	
3-1-3	Master interrupt-mask register failure	
3-1-4	Slave interrupt-mask register failure	
3-2-2	Interrupt vector loading failure	
3-2-4	Keyboard-controller test failure	
3-3-1	CMOS failure	
3-3-2	System configuration check failure	
3-3-3	Keyboard controller not detected	
3-3-4	Video memory test failure	
3-4-1	Screen initialization failure	
3-4-2	Screen-retrace test failure	
3-4-3	Video ROM search failure	
4-2-1	No timer tick	Faulty system board. See " <a href="#">Getting Help</a> ."
4-2-2	Shutdown test failure	

4-2-3	Gate A20 failure	
4-2-4	Unexpected interrupt in protected mode	See " <a href="#">Troubleshooting Expansion Cards</a> " in "Troubleshooting Your System."
4-3-1	Improperly installed or faulty memory modules	See " <a href="#">Troubleshooting System Memory</a> " in "Troubleshooting Your System."
4-3-2	No memory modules installed in the first memory module connector	Install a memory module in the first memory module connector. See " <a href="#">System Memory</a> " in "Installing System Components."
4-3-3	Faulty system board	Faulty system board. See " <a href="#">Getting Help</a> ."
4-3-4	Time-of-day clock stopped	See " <a href="#">Troubleshooting System Memory</a> " in "Troubleshooting Your System." If the problem persists, see " <a href="#">Getting Help</a> ."
4-4-1	Super I/O chip failure; faulty system board	Faulty system board. See " <a href="#">Getting Help</a> ."
4-4-4	Cache test failure; faulty processor	See " <a href="#">Troubleshooting the Microprocessors</a> " in "Troubleshooting Your System."

---

## Warning Messages

A warning message alerts you to a possible problem and prompts you to respond before the system continues a task. For example, before you format a diskette, a message will warn you that you may lose all data on the diskette. Warning messages usually interrupt the task and require you to respond by typing y (yes) or n (no).

 **NOTE:** Warning messages are generated by either the application or the operating system. For more information, see "[Finding Software Solutions](#)" and the documentation that accompanied the operating system or application.

---

## Diagnostic Messages

When you run system diagnostics, an error message may result. Diagnostic error messages are not covered in this section. Record the message on a copy of the Diagnostics Checklist in "Getting Help," and then follow the instructions in that section for obtaining technical assistance.

---

## Alert Messages

Systems management software generates alert messages for your system. Alert messages include information, status, warning, and failure messages for drive, temperature, fan, and power conditions. For more information, see the systems management software documentation.

---

## Baseboard Management Controller Messages

The Baseboard Management Controller (BMC) enables you to configure, monitor, and recover systems remotely. BMC uses the system's serial port and integrated NIC1 to support fault logging and SNMP alerting.

 **NOTE:** If the integrated network controller is used in an Ether Channel team or link aggregation team, the BMC management traffic will not function properly. For more information about network teaming, see the documentation for the network controller.

For additional information on using BMC, see the documentation for the BMC and systems management applications.

---

[Back to Contents Page](#)



[Back to Contents Page](#)

## Finding Software Solutions

### Dell™ PowerEdge™ 6850 Systems Installation and Troubleshooting Guide

- [Before You Begin](#)
- [Troubleshooting Errors and Conflicts](#)

Software problems can be caused by:

- 1 Improper installation or configuration of an application
- 1 Application conflicts
- 1 Input errors
- 1 Interrupt assignment conflicts

Ensure that you are installing the software application according to the software manufacturer's recommended procedures. If a problem occurs after you install the software, you might need to troubleshoot your software application and your system.

See the documentation that accompanied the software or contact the software manufacturer for detailed troubleshooting information.

 **NOTE:** If all of the system diagnostic tests complete successfully, then the problem is most likely caused by the software and not the hardware.

---

## Before You Begin

- 1 Scan the software media with antivirus software.
- 1 Read the software documentation before you run the installation utility.
- 1 Be prepared to respond to prompts from the installation utility.

The installation utility may require you to enter information about your system, such as how the operating system is configured, and the type of peripherals that are connected to the system. Have this information available before running the installation utility.

---

## Troubleshooting Errors and Conflicts

While configuring and running software, problems might occur that are caused by input errors, application conflicts, and/or IRQ assignment conflicts. The problems are sometimes indicated by error messages.

Error messages are generated by system hardware or software. "[Indicators, Messages, and Codes](#)" provides information about error messages that are hardware-based. If you receive an error message that is not listed, see your operating system or software program documentation for troubleshooting information.

### Input Errors

Pressing a specific key or set of keys at the wrong time may produce unexpected results. See the documentation that came with the software application to ensure that the values or characters you are entering are valid.

Ensure that your operating system is configured properly to run the application. Remember that whenever you change the parameters of the operating system, the changes can conflict with an application's operating requirements. After you configure the operating system, you may need to reinstall or reconfigure a software application so that it can run properly in its new environment.

### Application Conflicts

Some applications can leave unnecessary files or data behind after they are deleted from your system. Device drivers can also create application errors. If application errors occur, see your application device driver or operating system documentation for troubleshooting information.

### IRQ Assignment Conflicts

Most PCI devices can share an IRQ, but they cannot use an IRQ simultaneously. To avoid this type of conflict, see the documentation for each PCI device for specific IRQ requirements.

**Table 3-1.** IRQ Assignment Defaults

IRQ Line	Assignment
IRQ0	System timer
IRQ1	Keyboard controller

IRQ2	Interrupt controller 1 to enable IRQ8 through IRQ15
IRQ3	<i>Available</i>
IRQ4	Serial port 1 (COM1 and COM3)
IRQ5	Remote access controller
IRQ6	Diskette drive controller
IRQ7	<i>Available</i>
IRQ8	Real-time clock
IRQ9	ACPI functions (used for power management)
IRQ10	<i>Available</i>
IRQ11	<i>Available</i>
IRQ12	<i>Available</i>
IRQ13	Math coprocessor
IRQ14	IDE optical drive controller
IRQ15	<i>Available</i>

---

[Back to Contents Page](#)

[Back to Contents Page](#)

## Running the System Diagnostics

Dell™ PowerEdge™ 6850 Systems Installation and Troubleshooting Guide

- [Using Server Administrator Diagnostics](#)
- [System Diagnostics Features](#)
- [When to Use the System Diagnostics](#)
- [Running the System Diagnostics](#)
- [System Diagnostics Testing Options](#)
- [Using the Custom Test Options](#)

If you experience a problem with your system, run the diagnostics before calling for technical assistance. The purpose of the diagnostics is to test your system's hardware without requiring additional equipment or risking data loss. If you are unable to fix the problem yourself, service and support personnel can use diagnostics test results to help you solve the problem.

---

### Using Server Administrator Diagnostics

To assess a system problem, first use the online Server Administrator diagnostics. If you are unable to identify the problem, then use the system diagnostics.

To access the online diagnostics, log into the Server Administrator home page, and then click the **Diagnostics** tab. For information about using diagnostics, see the online help. For additional information, see the *Server Administrator User's Guide*.

---

### System Diagnostics Features

The system diagnostics provides a series of menus and options for particular device groups or devices. The system diagnostics menus and options allow you to:

- 1 Run tests individually or collectively.
  - 1 Control the sequence of tests.
  - 1 Repeat tests.
  - 1 Display, print, or save test results.
  - 1 Temporarily suspend testing if an error is detected or terminate testing when a user-defined error limit is reached.
  - 1 View help messages that briefly describe each test and its parameters.
  - 1 View status messages that inform you if tests are completed successfully.
  - 1 View error messages that inform you of problems encountered during testing.
- 

### When to Use the System Diagnostics

If a major component or device in the system does not operate properly, component failure may be indicated. As long as the microprocessor and the system's input/output devices (monitor, keyboard, and diskette drive) are functioning, you can use the system diagnostics to help identify the problem.

---

### Running the System Diagnostics

The system diagnostics can be run either from the utility partition on your hard drive or from a set of diskettes that you create using the *Dell OpenManage Server Assistant* CD. To use diskettes you must either have the optional diskette drive installed in your system, or a USB diskette drive.

- ➔ **NOTICE:** Use the system diagnostics to test only your system. Using this program with other systems may cause invalid results or error messages. In addition, use only the program that came with your system (or an updated version of that program).

#### From the Utility Partition

1. As the system boots, press <F10> during POST.
2. From the utility partition main menu under **Run System Utilities**, select **Run System Diagnostics**, or select **Run Memory Diagnostics** if you are troubleshooting memory.

#### From the Diagnostics Diskettes

1. Create a set of diagnostics diskettes from the *Dell OpenManage Server Assistant* CD. See "Using the Dell OpenManage Server Assistant CD" in your *User's Guide* for information on creating the diskettes.
2. If your system does have the optional diskette drive installed, obtain a USB diskette drive and connect it to the system.
3. Insert the first system diagnostics diskette, or the **MP Memory** diskette (if you are troubleshooting memory).
4. Reboot the system.

If the system fails to boot, see "Getting Help."

When you start the system diagnostics, a message is displayed stating that the diagnostics are initializing. Next, the **Diagnostics** menu appears. The menu allows you to run all or specific diagnostics tests or to exit the system diagnostics.

 **NOTE:** Before you read the rest of this section, start the system diagnostics so that you can see the utility on your screen.

## System Diagnostics Testing Options

Click the testing option in the **Main Menu** window. [Table 4-1](#) provides a brief explanation of testing options.

**Table 4-1.** System Diagnostics Testing Options

Testing Option	Function
Express Test	Performs a quick check of the system. This option runs device tests that do not require user interaction. Use this option to quickly identify the source of your problem.
Extended Test	Performs a more thorough check of the system. This test can take an hour or longer.
Custom Test	Tests a particular device.
Information	Displays test results.

## Using the Custom Test Options

When you select **Custom Test** in the **Main Menu** window, the **Customize** window appears and allows you to select the device(s) to be tested, select specific options for testing, and view the test results.

## Selecting Devices for Testing

The left side of the **Customize** window lists devices that can be tested. Devices are grouped by device type or by module, depending on the option you select. Click the (+) next to a device or module to view its components. Click (+) on any component to view the tests that are available. Clicking a device, rather than its components, selects all of the components of the device for testing.

## Selecting Diagnostics Options

Use the **Diagnostics Options** area to select how you want to test a device. You can set the following options:

- 1 **Non-Interactive Tests Only** — When checked, runs only tests that require no user intervention.
- 1 **Quick Tests Only** — When checked, runs only the quick tests on the device. Extended tests will not run when you select this option.
- 1 **Show Ending Timestamp** — When checked, time stamps the test log.
- 1 **Test Iterations** — Selects the number of times the test is run.
- 1 **Log output file pathname** — When checked, enables you to specify where the test log file is saved.

## Viewing Information and Results

The tabs in the **Customize** window provide information about the test and the test results. The following tabs are available:

- 1 **Results** — Displays the test that ran and the result.
- 1 **Errors** — Displays any errors that occurred during the test.
- 1 **Help** — Displays information about the currently selected device, component, or test.
- 1 **Configuration** — Displays basic configuration information about the currently selected device.
- 1 **Parameters** — If applicable, displays parameters that you can set for the test.

---

[Back to Contents Page](#)

## Troubleshooting Your System

### Dell™ PowerEdge™ 6850 Systems Installation and Troubleshooting Guide

- [Safety First—For You and Your System](#)
- [Start-Up Routine](#)
- [Checking Basic Power Problems](#)
- [Checking the Equipment](#)
- [Troubleshooting Basic I/O Functions](#)
- [Troubleshooting a NIC](#)
- [Responding to a Systems Management Software Alert Message](#)
- [Inside the System](#)
- [Opening the System](#)
- [Closing the System](#)
- [Troubleshooting a Wet System](#)
- [Troubleshooting a Damaged System](#)
- [Troubleshooting the System Battery](#)
- [Troubleshooting Power Supplies](#)
- [Troubleshooting System Cooling Problems](#)
- [Troubleshooting System Memory](#)
- [Troubleshooting a Diskette Drive](#)
- [Troubleshooting an Optical Drive](#)
- [Troubleshooting a SCSI Tape Drive](#)
- [Troubleshooting SCSI Hard Drives](#)
- [Troubleshooting the Integrated RAID Controller](#)
- [Troubleshooting a RAID Controller Card](#)
- [Troubleshooting Expansion Cards](#)
- [Troubleshooting the Microprocessors](#)

---

## Safety First—For You and Your System

To perform certain procedures in this document, you must remove the system cover and work inside the system. While working inside the system, do not attempt to service the system except as explained in this guide and elsewhere in your system documentation.

 **CAUTION:** Many repairs may only be done by a certified service technician. You should only perform troubleshooting and simple repairs as authorized in your product documentation, or as directed by the online or telephone service and support team. Damage due to servicing that is not authorized by Dell is not covered by your warranty. Read and follow the safety instructions that came with the product.

---

## Start-Up Routine

Look and listen during the system's start-up routine for the indications described in [Table 5-1](#).

**Table 5-1. Start-Up Routine Indications**

Look/listen for:	Action
An error message displayed on the monitor.	See " <a href="#">System Messages</a> " in "Indicators, Codes, and Messages."
A series of beeps emitted by the system.	See " <a href="#">System Beep Codes</a> " in "Indicators, Codes, and Messages."
Alert messages from the systems management software.	See the systems management software documentation.
The monitor's power indicator.	See " <a href="#">Troubleshooting the Video Subsystem</a> ."
The keyboard indicators.	See " <a href="#">Troubleshooting the Keyboard</a> ."
The diskette drive activity indicator.	See " <a href="#">Troubleshooting a Diskette Drive</a> ."
The optical drive activity indicator.	See " <a href="#">Troubleshooting an Optical Drive</a> ."
The hard-drive activity indicator.	See " <a href="#">Troubleshooting SCSI Hard Drives</a> ."
An unfamiliar constant scraping or grinding sound when you access a drive.	See " <a href="#">Getting Help</a> ."

---

## Checking Basic Power Problems

1. If the power indicator on the system front panel or power supply does not indicate that power is available to the system, ensure that the power cable is securely connected to the power supply.
2. If the system is connected to a PDU or UPS, turn the PDU or UPS off and then on.
3. If the PDU or UPS is not receiving power, plug it into another electrical outlet. If it still is not receiving power, try another PDU or UPS.
4. Reconnect the system to the electrical outlet and turn on the system.

 **NOTE:** The 1470-W power supplies require 200–240 V to operate. If they are plugged into 110-V electrical outlets, the power supplies do not power up.

If the system still is not working properly, see "[Troubleshooting Power Supplies](#)."

---

## Checking the Equipment

This section provides troubleshooting procedures for external devices attached to the system, such as the monitor, keyboard, or mouse. Before you perform any of the procedures, see "[Troubleshooting External Connections](#)."

## Troubleshooting External Connections

Loose or improperly connected cables are the most likely source of problems for the system, monitor, and other peripherals (such as a printer, keyboard, mouse, or other external device). Ensure that all external cables are securely attached to the external connectors on your system. See [Figure 2-1](#) and [Figure 2-2](#) for the front-panel and back-panel connectors on your system.

## Troubleshooting the Video Subsystem

### Problem

- 1 Monitor is not working properly.
- 1 Video memory is faulty.

### Action

1. Check the system and power connections to the monitor.
2. Run the appropriate online diagnostic test. See "[Using Server Administrator Diagnostics](#)" in "Running System Diagnostics."

If the tests run successfully, the problem is not related to video hardware. See "[Finding Software Solutions](#)."

If the tests fail, see "[Getting Help](#)."

## Troubleshooting the Keyboard

### Problem

- 1 System message indicates a problem with the keyboard.
- 1 Keyboard is not functioning properly.

### Action

1. Run the appropriate online diagnostic test. See "[Using Server Administrator Diagnostics](#)" in "Running System Diagnostics."
2. Examine the keyboard and its cable for signs of damage.
3. Swap the faulty keyboard with a working keyboard.

If the problem is resolved, replace the faulty keyboard.

4. Enter the System Setup program and ensure that the USB ports are enabled. See "Using the System Setup Program" in your *User's Guide*.

If the problem is not resolved, see "[Getting Help](#)."

## Troubleshooting the Mouse

### Problem

- 1 System message indicates a problem with the mouse.
- 1 Mouse is not functioning properly.

### Action

1. Run the appropriate online diagnostic test. See "Using Server Administrator Diagnostics" in "Running System Diagnostics."  
If the test fails, continue to the next step.
  2. Examine the mouse and its cable for signs of damage.  
If the mouse is not damaged, go to [step 5](#).  
If the mouse is damaged, continue to the next step.
  3. Swap the faulty mouse with a working mouse.  
If the problem is resolved, replace the faulty mouse.
  4. Enter the System Setup program and ensure that the USB ports are enabled. See "Using the System Setup Program" in your *User's Guide*.
  5. If the problem is not resolved, see "[Getting Help](#)."
- 

## Troubleshooting Basic I/O Functions

### Problem

1. Error message indicates a problem with the serial port.
1. Device connected to the serial port is not operating properly.

### Action

1. Enter the System Setup program and ensure that the serial port is enabled. See "Using the System Setup Program" in the *User's Guide*.
2. If the problem is confined to a particular application, see the application documentation for specific port configuration requirements that the program may require.
3. Run the appropriate online diagnostic test. See "[Using Server Administrator Diagnostics](#)" in "Running System Diagnostics."  
If the tests run successfully but the problem persists, see the appropriate procedure—"[Troubleshooting a Serial I/O Device](#)" or "[Troubleshooting a NIC](#)."

## Troubleshooting a Serial I/O Device

### Problem

1. Device connected to the serial port is not operating properly.

### Action

1. Turn off the system and any peripheral devices connected to the serial port.
2. Swap the serial interface cable with a working cable, and turn on the system and the serial device.  
If the problem is resolved, replace the interface cable.
3. Turn off the system and the serial device, and swap the device with a comparable device.
4. Turn on the system and the serial device.  
If the problem is resolved, replace the serial device.  
If the problem persists, see "[Getting Help](#)."



## Troubleshooting a USB Device

### Problem

- 1 System message indicates a problem with a USB device.
- 1 Device connected to a USB port is not operating properly.

### Action

1. Enter the System Setup program, and ensure that the USB ports are enabled. See "Using the System Setup Program" in your *User's Guide*.
2. Turn off the system and any USB devices.
3. Disconnect the USB devices, and connect the malfunctioning device to another USB connector.
4. Turn on the system and the reconnected device.

If the problem is resolved, the USB connector might be defective. See "[Getting Help](#)."

5. If possible, swap the interface cable with a working cable.

If the problem is resolved, replace the interface cable.

6. Turn off the system and the USB device, and swap the device with a comparable device.

7. Turn on the system and the USB device.

If the problem is resolved, replace the USB device.

If the problem persists, see "[Getting Help](#)."

---

## Troubleshooting a NIC

### Problem

- 1 NIC cannot communicate with network.

### Action

1. Run the appropriate online diagnostic test. See "[Using Server Administrator Diagnostics](#)" in "Running System Diagnostics."
2. Enter the System Setup program and confirm that the NICs are enabled. See "Using the System Setup Program" in your *User's Guide*.
3. Check the appropriate indicator on the NIC connector. See "[NIC Indicator Codes](#)" in "Indicators, Messages, and Codes."
  - 1 If the link indicator does not light, check all cable connections.
  - 1 If the activity indicator does not light, the network driver files might be damaged or missing.  
Remove and reinstall the drivers if applicable. See the NIC's documentation.
  - 1 Use another connector on the switch or hub.

If you are using a NIC card instead of an integrated NIC, see the documentation for the NIC card.

4. Ensure that the appropriate drivers are installed and the protocols are bound. See the NIC's documentation.
  5. Ensure that the NICs, hubs, and switches on the network are all set to the same data transmission speed. See the network equipment documentation.
  6. Ensure that all network cables are of the proper type and do not exceed the maximum length. See "Network Cable Requirements" in your *User's Guide*.
-

## Responding to a Systems Management Software Alert Message

Systems management software monitors critical system voltages and temperatures, fans, and hard drives in the system. Alert messages appear in the **Alert Log** window. For information about the **Alert Log** window, see the systems management software documentation.

---

### Inside the System

In [Figure 5-1](#), the bezel and system cover are removed to provide an interior view of the system.

➡ **NOTICE:** Do not remove the cooling shroud if the system is turned on. The cooling shroud must be installed to direct the airflow from the fans.

Figure 5-1. Inside the System

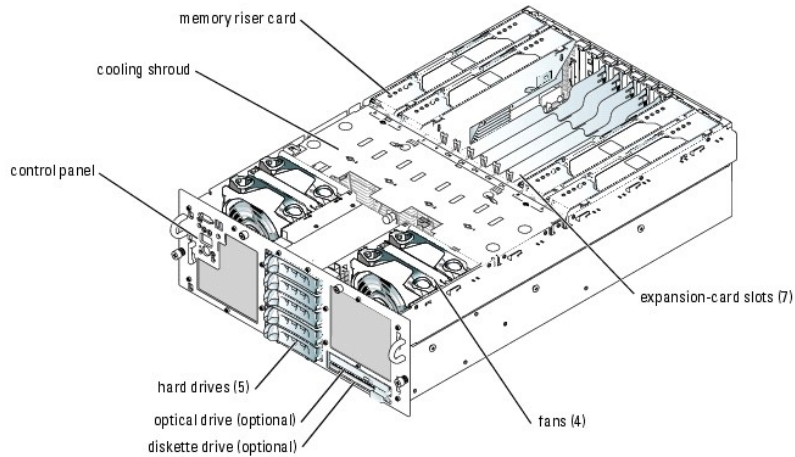

The system board holds the system's control circuitry and other electronic components. The processor and memory riser cards are installed directly on the system board. The system can accommodate up to seven expansion cards, four memory riser cards, and one integrated Fibre Channel module card.

The SCSI backplane supports up to five 3.5-inch SCSI hard drives. A removable drive carrier supports an optional diskette drive and optional optical drive. Power is supplied to the system board and drives through one or two power supplies.

---

### Opening the System

The system is enclosed by an optional bezel and cover. To upgrade or troubleshoot the system, remove the bezel and cover to access the drives and internal system components.

⚠ **CAUTION:** Many repairs may only be done by a certified service technician. You should only perform troubleshooting and simple repairs as authorized in your product documentation, or as directed by the online or telephone service and support team. Damage due to servicing that is not authorized by Dell is not covered by your warranty. Read and follow the safety instructions that came with the product.

1. If applicable, remove the bezel. See [Figure 5-2](#).
  - a. Unlock the keylock at the left end of the bezel.
  - b. Rotate the left end of the bezel away from the front panel.
  - c. Unhook the right end of the bezel and pull the bezel away from the system.

Figure 5-2. Installing and Removing the Optional Bezel

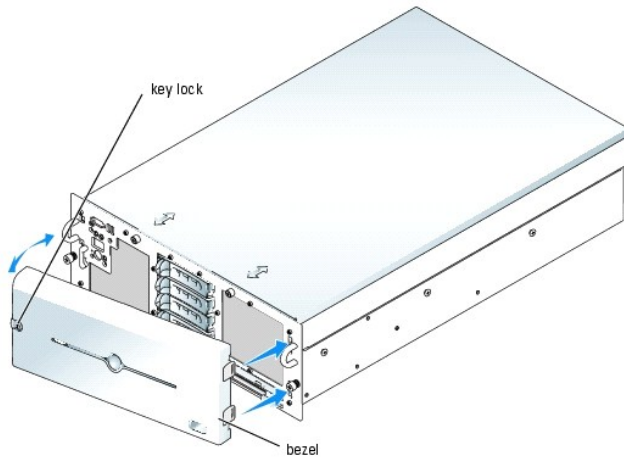

2. Unless you are installing a hot-plug component such as a cooling fan or hot-plug expansion card, turn off the system and attached peripherals, and disconnect the system from the electrical outlet and peripherals.
3. To remove the system cover, loosen the two captive screws at the front of the system. See [Figure 5-3](#).
4. Slide the cover backward about 1.3 cm (0.5 inch), and grasp the cover on both sides.
5. Carefully lift the cover away from the system.

**Figure 5-3. Installing and Removing the System Cover**

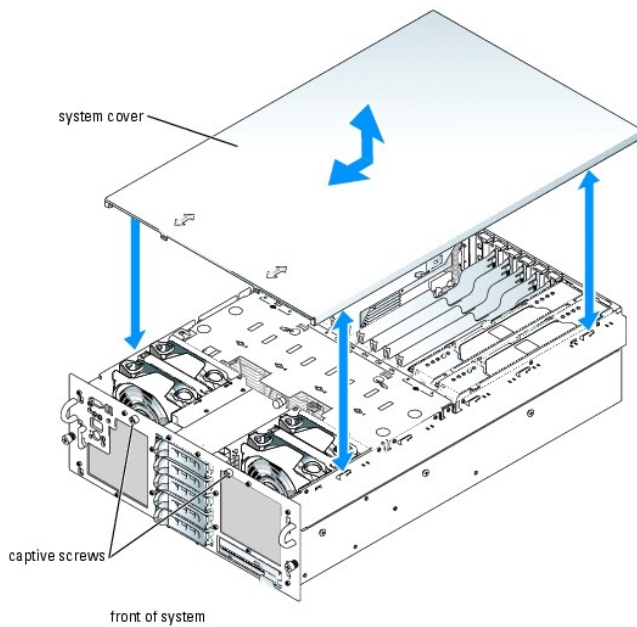

## Closing the System

1. Ensure that you did not leave tools or loose parts inside the system.
2. Place the cover over the sides of the chassis, and slide the cover forward.
3. Tighten the two captive screws at the front of the system to secure the cover. See [Figure 5-3](#).
4. Reconnect the peripheral cables.

5. Reconnect the system to the electrical outlet, and turn on the system.
  6. To replace the optional bezel, hook the right end of the bezel onto the chassis, then fit the free end of the bezel onto the system. Secure the bezel with the keylock. See [Figure 5-2](#).
- 

## Troubleshooting a Wet System

### Problem

1. Liquid spilled on the system.
1. Excessive humidity.

### Action

 **CAUTION:** Many repairs may only be done by a certified service technician. You should only perform troubleshooting and simple repairs as authorized in your product documentation, or as directed by the online or telephone service and support team. Damage due to servicing that is not authorized by Dell is not covered by your warranty. Read and follow the safety instructions that came with the product.

1. Turn off the system and attached peripherals, and disconnect the system from the electrical outlet.
  2. Open the system. See "[Opening the System](#)."
  3. Remove all expansion cards installed in the system. See "[Removing an Expansion Card](#)" in "Installing System Components."
  4. Remove all memory riser cards and memory modules installed in the system. See "[Removing Memory Modules](#)" in "Installing System Components."
  5. Remove the processor(s) from the system. See "[Removing a Processor](#)" in "Installing System Components."
  6. Let the system dry thoroughly for at least 24 hours.
  7. Replace the processor(s), memory modules and memory riser cards, and expansion cards. See "[Removing a Processor](#)," "[Installing Memory Modules](#)," and "[Installing an Expansion Card](#)" in "Installing System Components."
  8. Close the system. See "[Closing the System](#)."
  9. Reconnect the system to the electrical outlet, and turn on the system and peripherals.  
If the system does not start properly, see "[Getting Help](#)."
  10. Run the appropriate online diagnostic test. See "[Using Server Administrator Diagnostics](#)" in "Running the System Diagnostics."  
If the tests fail, see "[Getting Help](#)."
- 

## Troubleshooting a Damaged System

### Problem

1. System was dropped or damaged.

### Action

 **CAUTION:** Many repairs may only be done by a certified service technician. You should only perform troubleshooting and simple repairs as authorized in your product documentation, or as directed by the online or telephone service and support team. Damage due to servicing that is not authorized by Dell is not covered by your warranty. Read and follow the safety instructions that came with the product.

1. Open the system. See "[Opening the System](#)."
2. Ensure that the following components are properly installed:

- 1 Expansion cards
  - 1 Memory modules and memory riser cards
  - 1 Processor(s)
  - 1 Power supplies
  - 1 Fans
  - 1 Hard drives
3. Ensure that all cables are properly connected. See "[SCSI Hard-Drive Cabling Guidelines](#)" in "Installing Drives" for SCSI cabling information and [Figure A-3](#) for the locations of the system board connectors.
  4. Close the system. See "[Closing the System](#)."
  5. Run the system board tests in the system diagnostics. See "[Running the System Diagnostics](#)."  
If the tests fail, see "[Getting Help](#)."
- 

## Troubleshooting the System Battery

### Problem

- 1 System message indicates a problem with the battery.
- 1 System Setup program loses system configuration information.
- 1 System date and time do not remain current.

 **NOTE:** If the system is turned off for long periods of time (for weeks or months), the NVRAM may lose its system configuration information. This situation is caused by a defective battery.

### Action

1. Re-enter the time and date through the System Setup program. See "Using the System Setup Program" in your *User's Guide*.
2. Turn off the system and disconnect it from the electrical outlet for at least one hour.
3. Reconnect the system to the electrical outlet and turn on the system.
4. Enter the System Setup program.

If the date and time are not correct in the System Setup program, replace the battery. See "[System Battery](#)" in "Installing System Components."

If the problem is not resolved by replacing the battery, see "[Getting Help](#)."

 **NOTE:** Some software may cause the system time to speed up or slow down. If the system seems to operate normally except for the time kept in the System Setup program, the problem may be caused by software rather than by a defective battery.

---

## Troubleshooting Power Supplies

 **NOTE:** The 1470-W power supplies require 200–240 V to operate. If they are plugged into 110-V electrical outlets, the power supplies will not power up.

### Problem

- 1 System status indicator is amber.
- 1 Power supply fault indicator is amber.

### Action

1. Run the appropriate online diagnostics test. See "[Using Server Administrator Diagnostics](#)" in "Running the System Diagnostics."
2. Identify the faulty power supply.

The power supply's fault indicator is lit. See "[Power Indicator Codes](#)" in "Indicators, Messages, and Codes."

- ➡ **NOTICE:** The power supplies are hot-pluggable. Remove and install only one power supply at a time in a system that is powered on. The system is in the redundant mode when two power supplies are installed and both power supplies are connected to an AC power source. Operating the system with only one power supply installed for extended periods of time can cause the system to overheat.

3. Ensure that the power supply is properly installed by removing and reinstalling it. See "[Power Supplies](#)" in "Installing System Components."

- 🔍 **NOTE:** After installing a power supply, allow several seconds for the system to recognize the power supply and to determine if it is working properly. The power indicator turns green to signify that the power supply is functioning properly. See "[Power Indicator Codes](#)" in "Indicators, Messages, and Codes."

If the problem persists, remove the faulty power supply. See "[Removing a Power Supply](#)" in "Installing System Components."

4. Install a new power supply. See "[Installing a Power Supply](#)" in "Installing System Components."

If the problem persists, see "[Getting Help](#)."

---

## Troubleshooting System Cooling Problems

### Problem

- 1 System status indicator is amber.
- 1 Systems management software issues a fan-related error message.

### Action

- ⚠ **CAUTION:** Many repairs may only be done by a certified service technician. You should only perform troubleshooting and simple repairs as authorized in your product documentation, or as directed by the online or telephone service and support team. Damage due to servicing that is not authorized by Dell is not covered by your warranty. Read and follow the safety instructions that came with the product.

1. Run the appropriate diagnostic test. See "[Using Server Administrator Diagnostics](#)" in Running System Diagnostics."
  2. Open the system. See "[Opening the System](#)."
  3. Locate the fan referenced by the systems management software or diagnostics.  
See [Figure A-3](#) for the relative location of each fan.
  4. Ensure that the faulty fan is firmly seated in the fan bracket, to ensure contact with the fan power connector on the system board.
  5. Check that cables are not blocking the airflow within the system.
  6. Close the system. See "[Closing the System](#)."
  7. Reconnect the system to the electrical outlet, and turn on the system and attached peripherals.
  8. If the problem is not resolved, install a new fan. See "[Fans](#)" in "Installing System Components."
  9. If the replacement fan does not operate, see "[Getting Help](#)."
- 

## Troubleshooting System Memory

### Problem

- 1 Faulty memory riser card.
- 1 Faulty memory module.
- 1 Faulty system board.
- 1 System status indicator is amber.
- 1 LCD error code or system beep code indicates a memory problem.

- 1 Systems management software issues a memory-related message through the LCD display or systems management software.

## Action

### *Memory-related beep code during system startup.*

 **CAUTION:** Many repairs may only be done by a certified service technician. You should only perform troubleshooting and simple repairs as authorized in your product documentation, or as directed by the online or telephone service and support team. Damage due to servicing that is not authorized by Dell is not covered by your warranty. Read and follow the safety instructions that came with the product.

1. Turn off the system and attached peripherals, and disconnect the system from the electrical outlet.
2. Open the system. See "[Opening the System](#)."
3. Reseat the memory modules in their sockets. See "[Installing Memory Modules](#)" in "Installing System Components" and [Figure 6-10](#).
4. Close the system. See "[Closing the System](#)."
5. Reconnect the system to the electrical outlet, and turn on the system and attached peripherals.

If there is no memory-related beep code, the problem is resolved.

6. Turn off the system and attached peripherals, and disconnect the system from the electrical outlet.
  - a. Open the system. See "[Opening the System](#)."
  - b. Remove the memory riser cards. See "[Removing and Installing a Non-Hot-Pluggable Memory Riser Card](#)" in "Installing System Components."

 **NOTICE:** Label each memory module with the riser card letter and connector number to which it was connected.

- c. Remove all memory modules from the memory riser cards. See "[Removing Memory Modules](#)" in "Installing System Components."
- d. Replace one of the memory modules in socket DIMM1\_B in memory riser card A. See [Figure 6-10](#).
- e. Install memory riser card A. See "[Removing and Installing a Non-Hot-Pluggable Memory Riser Card](#)" in "Installing System Components."
- f. Close the system. See "[Closing the System](#)."
- g. Reconnect the system to the electrical outlet, and turn on the system and attached peripherals.
- h. If there is no memory-related beep code, the memory module is not faulty.

If the beep code reoccurs, the memory module is faulty and should be replaced.

7. Perform the following steps:
  - a. Turn off the system and attached peripherals, and disconnect the system from its electrical outlet.
  - b. Open the system. See "[Opening the System](#)."
  - c. Repeat [step d](#) through [step h](#) in [step 6](#) for each memory module installed.
8. If you have tested all the memory modules and the problem persists, or none of the memory modules passes, the system board is faulty. See "[Getting Help](#)."

### *The system starts up successfully but there are memory-related error messages.*

 **CAUTION:** Many repairs may only be done by a certified service technician. You should only perform troubleshooting and simple repairs as authorized in your product documentation, or as directed by the online or telephone service and support team. Damage due to servicing that is not authorized by Dell is not covered by your warranty. Read and follow the safety instructions that came with the product.

1. Turn off the system and attached peripherals, and disconnect the system from the electrical outlet.
2. Open the system. See "[Opening the System](#)."
3. Ensure that the memory modules are populated correctly. See "[General Memory Module Installation Guidelines](#)" in "Installing System Components."

If the memory modules are populated correctly, continue to the next step.

4. Reseat the memory modules in their sockets. See "[Installing Memory Modules](#)" in "Installing System Components."

5. Close the system. See "[Closing the System.](#)"
6. Reconnect the system to the electrical outlet, and turn on the system and attached peripherals.  
If there is no memory-related error message, the problem is resolved.  
If the problem persists, see "[Getting Help.](#)"

***There are memory-related error messages on the system LCD, or in the SEL.***

1. Enter the System Setup program and disable the **Redundant Memory** option, if applicable. See "Using the System Setup Program" in your *User's Guide*.
  2. Run the appropriate online diagnostic test. See "[Using Server Administrator Diagnostics](#)" in "Running System Diagnostics."
  3. Replace the memory module(s) identified by the diagnostics. See "[Installing Memory Modules](#)" in "Installing System Components."
  4. Enter the System Setup program and enable the **Redundant Memory** option, if disabled in [step 1](#).
  5. Restart the system. If there are still memory-related errors on the system LCD, or in the SEL, see "[Getting Help.](#)"
- 

## Troubleshooting a Diskette Drive

### Problem

1. Error message indicates a problem with the optional diskette drive.

### Action

 **CAUTION:** Many repairs may only be done by a certified service technician. You should only perform troubleshooting and simple repairs as authorized in your product documentation, or as directed by the online or telephone service and support team. Damage due to servicing that is not authorized by Dell is not covered by your warranty. Read and follow the safety instructions that came with the product.

1. Enter the System Setup program and verify that the diskette controller is enabled and the diskette drive is configured correctly. See "Using the System Setup Program" in the *User's Guide*.
2. Run the appropriate online diagnostic test. See "[Using Server Administrator Diagnostics](#)" in "Running System Diagnostics."
3. Turn off the system and attached peripherals, and disconnect the system from the electrical outlet.
4. Remove the diskette/optical drive carrier and ensure that the diskette drive cable is securely attached. Reinstall the diskette/optical drive carrier, making sure it is fully inserted and properly seated in the system chassis. See [Figure 7-3](#).
5. Reconnect the system to the electrical outlet, and turn on the system and attached peripherals.
6. Run the appropriate online diagnostic test to see whether the diskette drive works correctly. If it does not, proceed to the next step.
7. Turn off the system and attached peripherals, and disconnect the system from its electrical outlet.
8. Open the system. See "[Opening the System.](#)"
9. Remove all expansion cards installed in the system. See "[Removing an Expansion Card](#)" in "Installing System Components."
10. Close the system. See "[Closing the System.](#)"
11. Reconnect the system to the electrical outlet, and turn on the system and attached peripherals.
12. Run the appropriate online diagnostic test to see whether the diskette drive works correctly.  
If the tests run successfully, an expansion card may be conflicting with the diskette drive logic, or an expansion card may be faulty. Continue to the next step.  
If the tests fail, see "[Getting Help.](#)"



13. Turn off the system and attached peripherals, and disconnect the system from the electrical outlet.
  14. Open the system. See "[Opening the System](#)."
  15. Reinstall one of the expansion cards you removed in [step 9](#). See "[Installing an Expansion Card](#)" in "Installing System Components."
  16. Close the system. See "[Closing the System](#)."
  17. Reconnect the system to the electrical outlet, and turn on the system and attached peripherals.
  18. Run the appropriate online diagnostic test to see whether the diskette drive works correctly.
  19. Repeat [step 13](#) through [step 18](#) until all expansion cards are reinstalled or one of the expansion cards causes the tests to fail.
- If the problem is not resolved, see "[Getting Help](#)."
- 

## Troubleshooting an Optical Drive

### Problem

- 1 System cannot read data from a CD.
- 1 Optical drive indicator does not blink during boot.

### Action

 **CAUTION:** Many repairs may only be done by a certified service technician. You should only perform troubleshooting and simple repairs as authorized in your product documentation, or as directed by the online or telephone service and support team. Damage due to servicing that is not authorized by Dell is not covered by your warranty. Read and follow the safety instructions that came with the product.

1. Check for scratches or smudges on the CD surfaces and clean the CD.
2. Try using a different CD that you know works properly.
3. Enter the System Setup program and ensure that the drive's IDE controller is enabled. See "Using the System Setup Program" in the *User's Guide*.
4. Run the appropriate online diagnostic test. See "[Using Server Administrator Diagnostics](#)" in "Running System Diagnostics."
5. Turn off the system and attached peripherals, and disconnect the system from the electrical outlet.
6. Remove the diskette/optical drive carrier and ensure that the optical drive cable is securely attached. Reinstall the diskette/optical drive carrier, making sure it is fully inserted and properly seated in the system chassis. See [Figure 7-3](#).
7. Reconnect the system to the electrical outlet, and turn on the system and attached peripherals.

If the problem is not resolved, see "[Getting Help](#)."

---

## Troubleshooting a SCSI Tape Drive

### Problem

- 1 Defective tape drive.
- 1 Defective tape cartridge.
- 1 Missing or corrupted tape-backup software or tape drive device driver.
- 1 Defective optional SCSI controller card.

### Action

 **CAUTION:** Many repairs may only be done by a certified service technician. You should only perform troubleshooting and simple repairs as authorized in your product documentation, or as directed by the online or telephone service and support team. Damage due to servicing that is not authorized by Dell is not covered by your warranty. Read and follow the safety instructions that came with the product.

1. Enter the System Setup program and ensure that the secondary SCSI channel is enabled and set to SCSI.  
See "Using the System Setup Program" in the *User's Guide*.
  2. Remove the tape cartridge you were using when the problem occurred, and replace it with a tape cartridge that you know works.
  3. Ensure that the SCSI device drivers for the tape drive are installed and are configured correctly.
  4. Reinstall the tape-backup software as instructed in the tape-backup software documentation.
  5. Ensure that the tape drive's interface cable is connected to the tape drive and SCSI controller card, or the external SCSI connector on the system back panel. See [Figure 2-2](#).
  6. Verify that the tape drive is configured for a unique SCSI ID number and that the tape drive is terminated or not terminated, based on the interface cable used to connect the drive.  
See the documentation for the tape drive for instructions on selecting the SCSI ID number and enabling or disabling termination.
  7. Run the appropriate online diagnostics tests. See "[Using Server Administrator Diagnostics](#)" in "Running System Diagnostics."
  8. Turn off the system and attached peripherals, and disconnect the system from the electrical outlet.
  9. Open the system. See "[Opening the System](#)."
  10. If the drive is connected to an optional SCSI controller card, check that the card is firmly seated in its connector. See "[Installing an Expansion Card](#)" in "Installing System Components."
  11. If the drive is connected to the integrated SCSI controller on the system board using the optional external SCSI connector on the system back panel, check the cable connection to the system board.
  12. Close the system. See "[Closing the System](#)."
  13. Reconnect the system to the electrical outlet, and turn on the system, including attached peripherals.
  14. If the problem is not resolved, see the documentation for the tape drive for additional troubleshooting instructions.
  15. If you cannot resolve the problem, see "[Getting Help](#)."
- 

## Troubleshooting SCSI Hard Drives

### Problem

- 1 Device driver error.
- 1 Hard drive not recognized by the system.

### Action

 **CAUTION:** Many repairs may only be done by a certified service technician. You should only perform troubleshooting and simple repairs as authorized in your product documentation, or as directed by the online or telephone service and support team. Damage due to servicing that is not authorized by Dell is not covered by your warranty. Read and follow the safety instructions that came with the product.

 **NOTICE:** This procedure can destroy data stored on the hard drive. Before you continue, back up all files on the hard drive.

1. Run the appropriate online diagnostic test. See "[Using Server Administrator Diagnostics](#)" in "Running System Diagnostics."  
For information about testing the controller, see the SCSI or RAID controller's documentation.  
If the tests fail, continue to the next step.
2. Enter the System Setup program and ensure that the SCSI controller is enabled.  
See "Using the System Setup Program" in the *User's Guide*.

3. If the integrated SCSI host adapter controls the SCSI hard drives, restart the system and press <Ctrl><a> to enter the SCSI configuration utility program.

 **NOTE:** If your system has an optional RAID controller card or RAID on motherboard (ROMB) is enabled, restart the system and press <Ctrl><a> or <Ctrl><m>, depending on the utility. See the documentation supplied with the controller for information about the configuration utility.

4. Ensure that the primary SCSI channel is enabled, and restart the system.

See the documentation supplied with the controller for information about the configuration utility.

5. Verify that the device drivers are installed and configured correctly. See the operating system documentation.

6. Remove the hard drive and install it in another drive bay.

7. If the problem is resolved, reinstall the hard drive in the original bay. See "[Installing a SCSI Hard Drive](#)" in "Installing Drives."

If the hard drive functions properly in the original bay, the drive carrier could have intermittent problems. Replace the drive carrier. See "[Getting Help](#)."

If the problem persists, the SCSI backplane board has a defective connector. See "[Getting Help](#)."

8. Check the SCSI cable connections inside the system:

- a. Turn off the system, including any attached peripherals, and disconnect the system from the electrical outlet.
- b. Open the system. See "[Opening the System](#)."
- c. Verify that the SCSI cable is securely connected to the SCSI backplane, and to the SCSI host adapter on the system board, or a SCSI host adapter card installed in an expansion slot.
- d. Close the system. See "[Closing the System](#)."

9. Format and partition the hard drive. See the operating system documentation.

10. If possible, restore the files to the drive.

If the problem persists, see "[Getting Help](#)."

---

## Troubleshooting the Integrated RAID Controller

### Problem

1. Error message indicates a problem with the optional integrated RAID controller.

### Action

 **CAUTION:** Many repairs may only be done by a certified service technician. You should only perform troubleshooting and simple repairs as authorized in your product documentation, or as directed by the online or telephone service and support team. Damage due to servicing that is not authorized by Dell is not covered by your warranty. Read and follow the safety instructions that came with the product.

1. Run the appropriate online diagnostic test. See "[Using Server Administrator Diagnostics](#)" in "Running System Diagnostics."
2. Enter the System Setup program and ensure that the **Embedded RAID Controller** option is set to **RAID Enabled**. See "Using the System Setup Program" in your *User's Guide*.
3. Ensure that the integrated RAID controller is configured properly. See the RAID controller's documentation for information about configuration settings.  
If the problem is not resolved, continue to the next step.

4. Turn off the system and attached peripherals, and disconnect the system from its electrical outlet.

5. Open the system. See "[Opening the System](#)."

6. Ensure that the following RAID components are properly installed:

1. Memory module
1. RAID key

## 1 Battery

See "[Activating the Optional Integrated RAID Controller](#)" in "Installing Drives."

7. Close the system. See "[Closing the System](#)."
8. Reconnect the system to its electrical outlet, and turn on the system and attached peripherals.  
If the problem is not resolved, continue to the next step.
9. Turn off the system and attached peripherals, and disconnect the system from its electrical outlet.
10. Open the system. See "[Opening the System](#)."

**⚠ CAUTION:** Many repairs may only be done by a certified service technician. You should only perform troubleshooting and simple repairs as authorized in your product documentation, or as directed by the online or telephone service and support team. Damage due to servicing that is not authorized by Dell is not covered by your warranty. Read and follow the safety instructions that came with the product.

11. Replace the RAID battery. See "[Activating the Optional Integrated RAID Controller](#)" in "Installing Drives."
12. Close the system. See "[Closing the System](#)."
13. Reconnect the system to its electrical outlet, and turn on the system and attached peripherals.  
If the problem persists, see "[Getting Help](#)."

---

## Troubleshooting a RAID Controller Card

**🔧 NOTE:** When troubleshooting a RAID controller card, also see the documentation for your operating system and the RAID controller.

### Problem

1. Error message indicates a RAID controller problem.
1. RAID controller performs incorrectly or not at all.

### Action

**⚠ CAUTION:** Many repairs may only be done by a certified service technician. You should only perform troubleshooting and simple repairs as authorized in your product documentation, or as directed by the online or telephone service and support team. Damage due to servicing that is not authorized by Dell is not covered by your warranty. Read and follow the safety instructions that came with the product.

1. Run the appropriate online diagnostic test. See "[Using Server Administrator Diagnostics](#)" in "Running the System Diagnostics."
2. Turn off the system and attached peripherals, and disconnect the system from the electrical outlet.
3. Open the system. See "[Opening the System](#)."
4. Ensure that the controller card is firmly seated in its connector. See "[Installing an Expansion Card](#)" in "Installing System Components."
5. Ensure that the appropriate cables are firmly connected to their corresponding connectors on the controller card and SCSI backplane.
6. Close the system. See "[Closing the System](#)."
7. Reconnect the system to the electrical outlet, and turn on the system and attached peripherals.  
If the problem persists, see the RAID controller's documentation for more information on troubleshooting.

---

## Troubleshooting Expansion Cards

**🔧 NOTE:** When troubleshooting an expansion card, see the documentation for your operating system and the expansion card.

## Problem

- 1 Error message indicates a problem with an expansion card.
- 1 Expansion card performs incorrectly or not at all.

## Action

 **CAUTION:** Many repairs may only be done by a certified service technician. You should only perform troubleshooting and simple repairs as authorized in your product documentation, or as directed by the online or telephone service and support team. Damage due to servicing that is not authorized by Dell is not covered by your warranty. Read and follow the safety instructions that came with the product.

1. Run the appropriate online diagnostic test. See "[Using Server Administrator Diagnostics](#)" in "Running System Diagnostics."
2. Turn off the system and attached peripherals, and disconnect the system from the electrical outlet.
3. Open the system. See "[Opening the System](#)."
4. Ensure that each expansion card is firmly seated in its connector. See "[Installing an Expansion Card](#)" in "Installing System Components."
5. Close the system. See "[Closing the System](#)."
6. Reconnect the system to the electrical outlet, and turn on the system and attached peripherals.

If the problem persists, go to the next step.

7. Turn off the system and attached peripherals, and disconnect the system from the electrical outlet.
8. Open the system. See "[Opening the System](#)."
9. Remove all expansion cards installed in the system. See "[Removing an Expansion Card](#)" in "Installing System Components."
10. Close the system. See "[Closing the System](#)."
11. Reconnect the system to the electrical outlet, and turn on the system and attached peripherals.
12. Run the appropriate online diagnostic test.

If the tests fail, see "[Getting Help](#)."

13. For each expansion card you removed in [step 9](#), perform the following steps:
  - a. Turn off the system and attached peripherals, and disconnect the system from the electrical outlet.
  - b. Open the system. See "[Opening the System](#)."
  - c. Reinstall one of the expansion cards. See "[Installing an Expansion Card](#)."
  - d. Close the system. See "[Closing the System](#)."
  - e. Run the appropriate diagnostic test.

If the tests fail, see "[Getting Help](#)."

---

## Troubleshooting the Microprocessors

### Problem

- 1 Error message indicates a processor problem.
- 1 A heat sink is not installed for each processor.

### Action

 **CAUTION:** Many repairs may only be done by a certified service technician. You should only perform troubleshooting and simple repairs as authorized in your product documentation, or as directed by the online or telephone service and support team. Damage due to servicing that is not authorized by Dell is not covered by your warranty. Read and follow the safety instructions that came with the product.

1. Run the appropriate online diagnostics test. See "[Using Server Administrator Diagnostics](#)" in "Running the System Diagnostics."
2. Turn off the system and attached peripherals, and disconnect the system from the electrical outlet.
3. Open the system. See "[Opening the System](#)."
4. Remove the cooling shroud from the system. See "[Cooling Shroud](#)" in "Installing System Components."
5. Ensure that each processor and heat sink is properly installed. See "[Installing a Processor](#)" in "Installing System Components."
6. Close the system. See "[Closing the System](#)."
7. Reconnect the system to the electrical outlet, and turn on the system and attached peripherals.
8. Run the appropriate online diagnostic test.  
If the tests fail or the problem persists, continue to the next step.
9. Turn off the system and attached peripherals, and disconnect the system from the electrical outlet.
10. Open the system. See "[Opening the System](#)."
11. Remove the other processors, if installed, leaving only processor 1 installed. See "[Removing a Processor](#)" in "Installing System Components."  
To locate the processors, see [Figure A-3](#).  
If only one processor is installed, see "[Getting Help](#)."
12. Close the system. See "[Closing the System](#)."
13. Reconnect the system to the electrical outlet, and turn on the system and attached peripherals.
14. Run the appropriate online diagnostic test.  
If the tests complete successfully, go to [step 20](#).
15. Turn off the system and attached peripherals, and disconnect the system from the electrical outlet.
16. Open the system. See "[Opening the System](#)."
17. Replace processor 1 with another processor of the same capacity. See "[Removing a Processor](#)" in "Installing System Components."
18. Close the system. See "[Closing the System](#)."
19. Run the appropriate online diagnostic test.  
If the tests complete successfully, replace processor 1. See "[Getting Help](#)."
20. Turn off the system and attached peripherals, and disconnect the system from the electrical outlet.
21. Open the system. See "[Opening the System](#)."
22. Reinstall the other processors that you removed in [step 11](#). See "[Installing a Processor](#)" in "Installing System Components."
23. Close the system. See "[Closing the System](#)."
24. Reconnect the system to the electrical outlet, and turn on the system and attached peripherals.  
If the problem persists, see "[Getting Help](#)."

## Installing System Components

### Dell™ PowerEdge™ 6850 Systems Installation and Troubleshooting Guide

- [System Battery](#)
- [Fans](#)
- [Cooling Shroud](#)
- [Power Supplies](#)
- [Expansion Cards](#)
- [Integrated Fibre Channel Module Card](#)
- [System Memory](#)
- [Processor](#)

This section describes how to install the following system components:

- 1 System battery
- 1 Cooling fans
- 1 Power supplies
- 1 Expansion cards
- 1 System memory
- 1 Processors

For information on adding SCSI devices, other types of drives, or activating the optional integrated RAID controller, see "[Installing Drives.](#)"

---

## System Battery

### Replacing the System Battery

**⚠ CAUTION:** Many repairs may only be done by a certified service technician. You should only perform troubleshooting and simple repairs as authorized in your product documentation, or as directed by the online or telephone service and support team. Damage due to servicing that is not authorized by Dell is not covered by your warranty. Read and follow the safety instructions that came with the product.

1. Enter the System Setup program and record the option settings on the System Setup screens.  
  
See "Using the System Setup Program" in the *User's Guide*.
2. Turn off the system and attached peripherals, and disconnect the system from the electrical outlet.
3. Open the system. See "[Opening the System](#)" in "Troubleshooting Your System."
4. Remove the memory riser cards A and B. See "[Removing and Installing a Non-Hot-Pluggable Memory Riser Card.](#)"
5. Remove the system battery. See [Figure A-3](#) for the battery connector location on the system board.

- ➡ NOTICE:** To avoid damage to the battery connector, you must firmly support the connector while installing or removing a battery.
- a. Support the battery connector by pressing down firmly on the positive side of the connector. See [Figure 6-1](#).
  - b. While supporting the battery connector, press the battery toward the positive side of the connector and pry it up out of the securing tabs at the negative side of the connector.

**Figure 6-1. Replacing the System Battery**

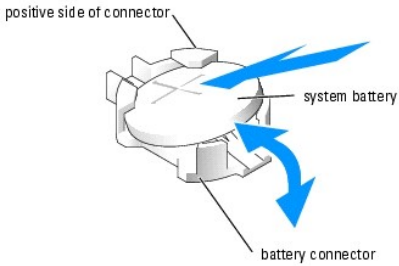

6. Install the new system battery with the side labeled "+" facing up. See [Figure 6-1](#).

**NOTE:** The side of the battery labeled "+" must face toward the open side of the battery socket.

7. Install the new system battery.
  - a. Support the battery connector by pressing down firmly on the positive side of the connector.
  - b. Hold the battery with the "+" facing up, and slide it under the securing tabs at the positive side of the connector.
  - c. Press the battery straight down into the connector until it snaps into place.
8. Replace the memory riser cards A and B. See "[Removing and Installing a Non-Hot-Pluggable Memory Riser Card](#)."
9. Close the system. See "[Closing the System](#)" in "Troubleshooting Your System."
10. Enter the System Setup program to confirm that the battery operates properly.
11. From the main screen, select **System Time** to enter the correct time and date.
12. Re-enter any system configuration information that is no longer displayed on the System Setup screens, and then exit the System Setup program.
13. To test the newly installed battery, see "[Troubleshooting the System Battery](#)" in "Troubleshooting Your System."

---

## Fans

The system's four hot-plug fans (fans 1 through 4) provide cooling for the inside of the system. See [Figure 6-2](#).

**NOTE:** In the event of a problem with a particular fan, the fan's number is referenced by the system's management software, allowing you to easily identify and replace the proper fan.

**Figure 6-2. System Fans**

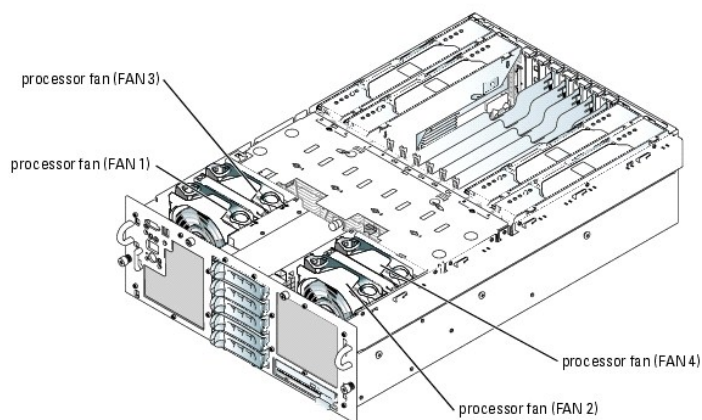

## Removing a System Fan



**⚠ CAUTION:** Many repairs may only be done by a certified service technician. You should only perform troubleshooting and simple repairs as authorized in your product documentation, or as directed by the online or telephone service and support team. Damage due to servicing that is not authorized by Dell is not covered by your warranty. Read and follow the safety instructions that came with the product.

1. Open the system. See ["Opening the System"](#) in "Troubleshooting Your System."
2. Compress the two latches on the top of the fan, then remove the fan. See [Figure 6-3](#).

Figure 6-3. Installing and Removing a System Fan

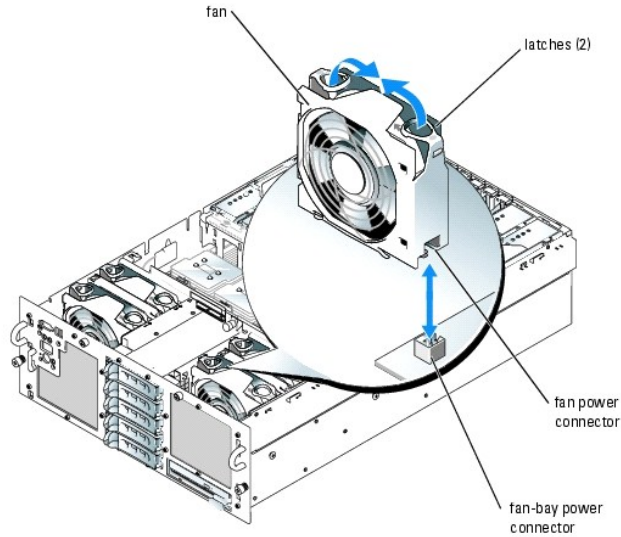

## Installing a System Fan

**⚠ CAUTION:** Many repairs may only be done by a certified service technician. You should only perform troubleshooting and simple repairs as authorized in your product documentation, or as directed by the online or telephone service and support team. Damage due to servicing that is not authorized by Dell is not covered by your warranty. Read and follow the safety instructions that came with the product.

1. Open the system. See ["Opening the System"](#) in "Troubleshooting Your System."
2. Orient the fan so that its bottom power connector is on the same side as the fan connector on the bottom of the fan bay.
3. Slide the fan into the fan bay, and then gently press it until it locks into position.

---

## Cooling Shroud

The cooling shroud directs airflow within the system.

## Removing the Cooling Shroud

**➡ NOTICE:** Do not remove the cooling shroud if the system is turned on. The cooling shroud must be installed to direct the airflow from the fans.

To remove the cooling shroud, use the four finger holes to lift the shroud straight up from the system. See [Figure 6-4](#).

Figure 6-4. Removing and Installing the Cooling Shroud

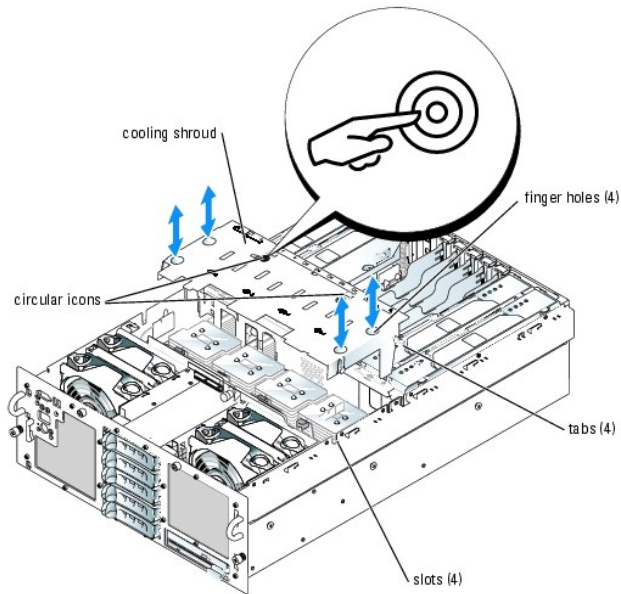

## Installing the Cooling Shroud

1. Align the four tabs on the sides of the shroud with the four slots on the chassis. See [Figure 6-4](#).
2. Slowly lower the shroud straight down into the system.
3. Gently press down on the circular icons on top of the shroud.

---

## Power Supplies

### Removing a Power Supply

- 🔧 **NOTE:** The 1470-W power supplies require 200–240 V to operate. If they are plugged into 110-V electrical outlets, the power supplies do not power up.
- 👉 **NOTICE:** The system is in the redundant mode when two power supplies are installed and both power supplies are connected to an AC power source. Remove and replace only one power supply at a time in a system that is powered on.

1. Disconnect the power cable from the power source.
2. Disconnect the power cable from the power supply.
3. Press the lever release latch, then open the lever and slide the power supply out of the chassis. See [Figure 6-5](#).

- 🔧 **NOTE:** You may have to unlatch and lift the cable management arm if it interferes with power-supply removal. For information about the cable management arm, see the system's *Rack Installation Guide*.

Figure 6-5. Installing and Removing a Power Supply

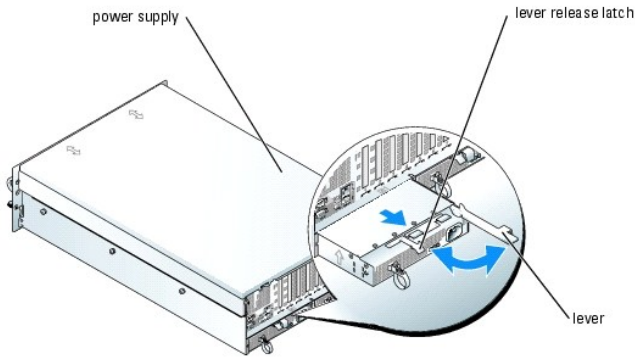

## Installing a Power Supply

1. Holding the lever in the open position, slide the new power supply into the chassis until the lever contacts the system chassis. See [Figure 6-5](#).
2. Close the lever until the power supply is fully seated and the lever snaps behind the lever release latch. See [Figure 6-5](#).

 **NOTE:** If you unlatched the cable management arm in [step 3](#) of the previous procedure, relatch it. For information about the cable management arm, see the system's *Rack Installation Guide*.

3. Connect the power cable to the power supply and plug the cable into a power outlet.

 **NOTICE:** When connecting the power cable, insert the cable through the strain-relief loop.

After installing a new power supply, allow several seconds for the system to recognize the power supply and determine whether it is working properly. The power-on indicator will turn green to signify that the power supply is functioning properly (see [Figure 2-4](#)).

---

## Expansion Cards

Your system supports up to seven full-length expansion cards installed in connectors on the system board. See [Figure 6-6](#) for the locations of the connectors. The expansion slots are configured as follows:

- o Slot 1 is a hot-plug, x8 lane-width PCI-Express expansion slot.
- o Slot 2 is a hot-plug, 3.3-V, 64-bit, 133-MHz PCI-X expansion slot.
- o Slots 3 through 5 are hot-plug, x4 lane-width PCI-Express expansion slots.
- o Slots 6 and 7 are non-hot-plug, 3.3-V, 64-bit, 100-MHz PCI-X expansion slots.

 **NOTE:** If you are installing a Remote Access Control (RAC) card, it must be installed in card slot 7 to enable it to be cabled to the RAC connector on the system board. See [Figure A-3](#) for the location of the RAC connector.

 **NOTE:** Slot 7 supports full-height, half-length cards only.

 **NOTE:** The system board also provides a proprietary connector for an optional non-hot-plug Fibre Channel module card. Do not use that connector for any other card other than the Fibre Channel module card. See "[Integrated Fibre Channel Module Card](#)" for more information about the connector.

**Figure 6-6. Expansion Slots**

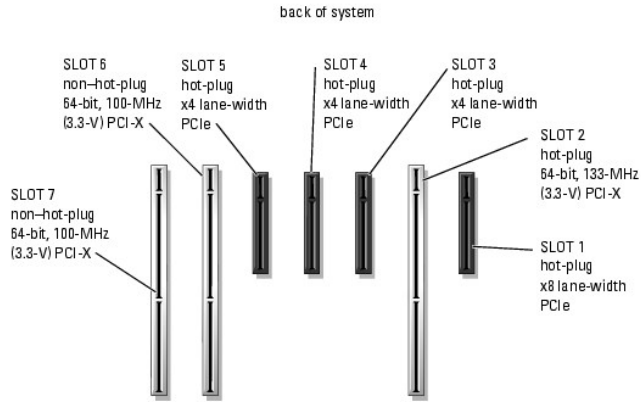

## Hot-Plug Expansion Cards

Your system supports PCI Express hot-plug expansion cards in slots 1, 3, 4, and 5 and one PCI-X hot-plug expansion card in slot 2. (Slots 6 and 7 are non-hot-plug PCI-X expansion card connectors.) The indicators on each expansion slot insulator show the state of the expansion-card connector. See [Figure 6-8](#) and [Table 6-1](#).

- ➡ **NOTICE:** Your system's operating system and the expansion card itself must both support hot-plug installation and removal.
- ➡ **NOTICE:** To avoid damage to the expansion card or system board, refer to the expansion-slot indicator when you add or remove a PCI Express expansion card.

Table 6-1. Hot-Plug Expansion Slot Indicators

Green Power Indicator	Amber Attention Indicator	Safe to Add / Remove Card	Description
Off	Off	Yes	Connector power is off
On	Off	No	Connector power is on
Flash	Off	No	Connector is being powered up or powered down
Off	On	Yes	Fault
On	Flash	No	Slot is being identified

## Installing an Expansion Card

- ⚠ **CAUTION:** Many repairs may only be done by a certified service technician. You should only perform troubleshooting and simple repairs as authorized in your product documentation, or as directed by the online or telephone service and support team. Damage due to servicing that is not authorized by Dell is not covered by your warranty. Read and follow the safety instructions that came with the product.

## Installing a Non-Hot-Plug Expansion Card

- ⚠ **CAUTION:** Many repairs may only be done by a certified service technician. You should only perform troubleshooting and simple repairs as authorized in your product documentation, or as directed by the online or telephone service and support team. Damage due to servicing that is not authorized by Dell is not covered by your warranty. Read and follow the safety instructions that came with the product.
- 🔧 **NOTE:** Slot 7 supports full-height, half-length cards only.

Slots 6 and 7 are non-hot-plug PCI-X expansion card connectors. To install a non-hot-plug expansion card, perform the following steps:

1. Turn off the system and attached peripherals, and disconnect the system from the electrical outlet.
2. Open the system. See "[Opening the System](#)" in "Troubleshooting Your System."
3. Open the plastic expansion-card retainer adjacent to the back of the empty slot. See [Figure 6-7](#).

Figure 6-7. Installing and Removing Non-Hot-Plug Expansion Cards

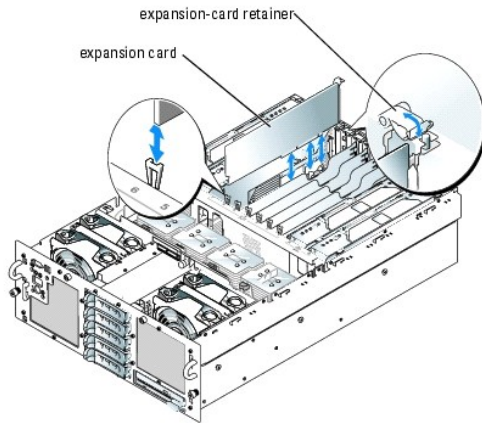

4. Remove the filler bracket on the slot that you are using.

**NOTE:** Keep this bracket if you need to remove the expansion card. Filler brackets must be installed over empty expansion-card slots to maintain Federal Communications Commission (FCC) certification of the system. The brackets also keep dust and dirt out of the system and aid in proper cooling and airflow inside the system.

5. Insert the expansion card firmly into the expansion-card connector until the card is fully seated.

**NOTE:** Ensure that the expansion-card bracket is also inserted into the securing slot at the bottom of the bracket slot.

6. Close the expansion-card retainer. See [Figure 6-7](#).

7. Connect any internal or external cable(s) to the expansion card.

8. Close the system. See "[Closing the System](#)" in "Troubleshooting Your System."

## Installing a Hot-Plug Expansion Card

**CAUTION:** Many repairs may only be done by a certified service technician. You should only perform troubleshooting and simple repairs as authorized in your product documentation, or as directed by the online or telephone service and support team. Damage due to servicing that is not authorized by Dell is not covered by your warranty. Read and follow the safety instructions that came with the product.

Your system supports PCI Express hot-plug expansion cards in slots 1, 3, 4, and 5 and one PCI-X hot-plug expansion card in slot 2. See [Figure 6-6](#). To install a hot-plug expansion card, perform the following steps.

**NOTICE:** Your system's operating system and the expansion card itself must both support hot-plug installation and removal.

1. Open the system. See "[Opening the System](#)" in "Troubleshooting Your System."
2. To power down the expansion slot, press the indicator/switch at the end of the expansion slot. See [Figure 6-8](#).
3. Wait until the green and amber indicators for the slot are both off. See [Figure 6-8](#) and [Table 6-1](#).

**Figure 6-8. Installing and Removing Hot-Plug Expansion Cards**

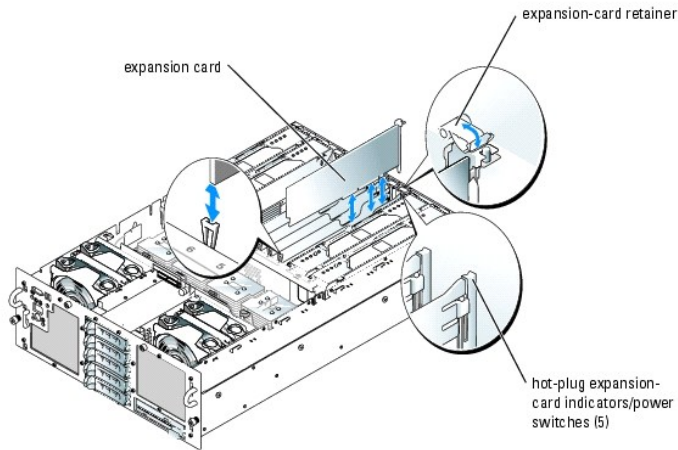

4. Open the plastic expansion-card retainer adjacent to the back of the empty slot. See [Figure 6-8](#).

5. Remove the filler bracket on the slot that you are using.

**NOTICE:** Be very careful when removing the bracket to avoid dropping it onto the system board and damaging the system board.

**NOTE:** Keep this bracket if you need to remove the expansion card. Filler brackets must be installed over empty expansion-card slots to maintain FCC certification of the system. The brackets also keep dust and dirt out of the system and aid in proper cooling and airflow inside the system.

6. Insert the expansion card firmly into the expansion-card connector until the card is fully seated. Ensure that the expansion-card bracket is also inserted into the securing slot on the chassis's back panel.

7. Close the expansion-card retainer.

8. Connect any internal or external cable(s) to the expansion card.

9. Power up the expansion slot by pressing the indicator/switch at the end of the expansion slot. See [Figure 6-8](#).

The green indicator flashes while the card is powering up, and then remains on after it is powered up. See [Table 6-1](#).

10. Close the system. See "[Closing the System](#)" in "Troubleshooting Your System."

## Removing an Expansion Card

### Removing a Non-Hot Plug Expansion Card

**CAUTION:** Many repairs may only be done by a certified service technician. You should only perform troubleshooting and simple repairs as authorized in your product documentation, or as directed by the online or telephone service and support team. Damage due to servicing that is not authorized by Dell is not covered by your warranty. Read and follow the safety instructions that came with the product.

1. Turn off the system and attached peripherals, and disconnect the system from the electrical outlet.

2. Open the system. See "[Opening the System](#)" in "Troubleshooting Your System."

3. Disconnect any internal or external cable(s) that are connected to the expansion card.

4. Open the expansion-card retainer adjacent to the slot. See [Figure 6-7](#).

5. Grasp the expansion card and carefully remove it from the system-board connector.

6. If you are permanently removing the card, replace the metal filler bracket over the empty card-slot opening.

**NOTE:** Filler brackets must be installed over empty expansion-card slots to maintain FCC certification of the system. The brackets also keep dust and dirt out of the system and aid in proper cooling and airflow inside the system.

7. Close the expansion-card retainer.
8. Close the system. See "[Closing the System](#)" in "Troubleshooting Your System."

## Removing a Hot-Plug Expansion Card

**⚠ CAUTION:** Many repairs may only be done by a certified service technician. You should only perform troubleshooting and simple repairs as authorized in your product documentation, or as directed by the online or telephone service and support team. Damage due to servicing that is not authorized by Dell is not covered by your warranty. Read and follow the safety instructions that came with the product.

1. Open the system. See "[Opening the System](#)" in "Troubleshooting Your System."
2. To power down the expansion slot, press the indicator/switch at the end of the expansion slot. See [Figure 6-8](#).
3. Wait until the green and amber indicators for the slot are both off. See [Figure 6-8](#) and [Table 6-1](#).
4. Disconnect any internal or external cable(s) that are connected to the expansion card.
5. Open the expansion-card retainer adjacent to the PCI slot.
6. Grasp the expansion card and carefully remove it from the system-board connector.
7. If you are permanently removing the card, replace the metal filler bracket over the empty card-slot opening.

**🔧 NOTE:** Filler brackets must be installed over empty expansion-card slots to maintain FCC certification of the system. The brackets also keep dust and dirt out of the system and aid in proper cooling and airflow inside the system.

8. Close the expansion-card retainer.
  9. Close the system. See "[Closing the System](#)" in "Troubleshooting Your System."
- 

## Integrated Fibre Channel Module Card

Your system supports an optional non-hot-plug Fibre Channel module card that provides two independent serial Fibre Channel ports. The Fibre Channel module card installs in a proprietary connector on the system board. See [Figure 6-9](#) for the location of the Fibre Channel connector.

## Installing a Fibre Channel Module Card

**⚠ CAUTION:** Many repairs may only be done by a certified service technician. You should only perform troubleshooting and simple repairs as authorized in your product documentation, or as directed by the online or telephone service and support team. Damage due to servicing that is not authorized by Dell is not covered by your warranty. Read and follow the safety instructions that came with the product.

To install a non-hot-plug Fibre Channel module card, perform the following steps:

1. Turn off the system and attached peripherals, and disconnect the system from the electrical outlet.
2. Open the system. See "[Opening the System](#)" in "Troubleshooting Your System."
3. Remove memory risers cards C and D. See "[Removing and Installing a Non-Hot-Pluggable Memory Riser Card](#)."
4. Open the plastic Fibre Channel module card retainer adjacent to the back of the empty slot. See [Figure 6-9](#).

**Figure 6-9. Installing and Removing a Fibre Channel Module Card**

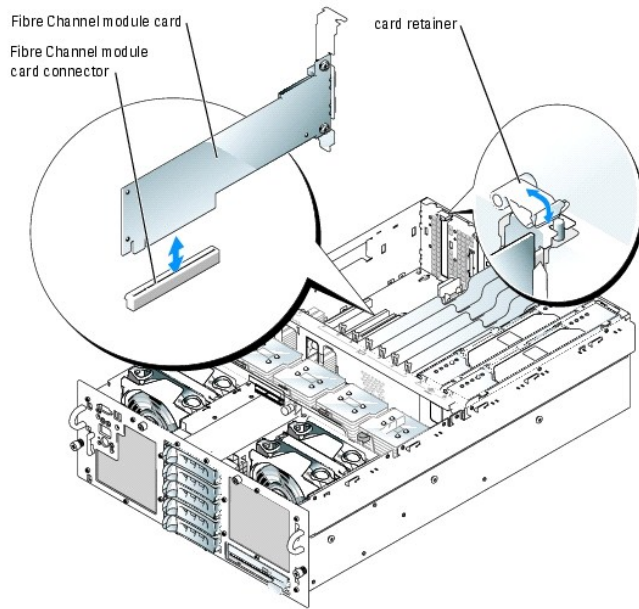

5. Remove the filler bracket on the slot.

**NOTE:** Keep this bracket if you need to remove the Fibre Channel module card. Filler brackets must be installed over empty card slots to maintain Federal Communications Commission (FCC) certification of the system. The brackets also keep dust and dirt out of the system and aid in proper cooling and airflow inside the system.

6. Insert the Fibre Channel module card firmly into the Fibre Channel module card connector until the card is fully seated.

**NOTE:** Ensure that the Fibre Channel module card bracket is also inserted into the securing slot at the bottom of the bracket slot.

7. Close the Fibre Channel module card retainer. See [Figure 6-9](#).
8. Connect any internal or external cable(s) to the card.
9. Close the system. See "[Closing the System](#)" in "Troubleshooting Your System."

## Removing a Fibre Channel Module Card

**CAUTION:** Many repairs may only be done by a certified service technician. You should only perform troubleshooting and simple repairs as authorized in your product documentation, or as directed by the online or telephone service and support team. Damage due to servicing that is not authorized by Dell is not covered by your warranty. Read and follow the safety instructions that came with the product.

1. Turn off the system and attached peripherals, and disconnect the system from the electrical outlet.
2. Open the system. See "[Opening the System](#)" in "Troubleshooting Your System."
3. Remove memory riser cards C and D. See "[Removing and Installing a Non-Hot-Pluggable Memory Riser Card](#)."
4. Disconnect any internal or external cable(s) that are connected to the card.
5. Open the Fibre Channel module card retainer adjacent to the slot. See [Figure 6-9](#).
6. Grasp the Fibre Channel module card and carefully remove it from the system-board connector.
7. If you are permanently removing the card, replace the metal filler bracket over the empty card-slot opening.

**NOTE:** Filler brackets must be installed over empty card slots to maintain FCC certification of the system. The brackets also keep dust and dirt out of the system and aid in proper cooling and airflow inside the system.



8. Close the Fibre Channel module card retainer.
9. Close the system. See "[Closing the System](#)" in "Troubleshooting Your System."

---

## System Memory

You can upgrade your system memory to a maximum of 64 GB by installing combinations of 256-MB, 512-MB, 1-GB, 2-GB, or 4-GB (when available) 2-way registered ECC PC2-3200 (DDR II 400) memory. The memory sockets are located on the memory riser card(s).

**NOTE:** A single-memory module configuration is not supported, and the maximum memory configuration depends on the availability of single-rank 2-GB memory modules.

**NOTICE:** If you remove your original memory modules from the system during a memory upgrade, keep them separate from any new memory modules that you may have. Use only registered ECC PC2-3200 compliant (DDR II 400) memory modules.

The system memory is located in sockets on the memory riser card(s). See [Figure 6-10](#). The memory module sockets are arranged in two banks per riser card on two channels (A and B). The memory module banks are identified as follows:

- 1 Bank 1: DIMM\_1A and DIMM\_1B
- 1 Bank 2: DIMM\_2A and DIMM\_2B

**Figure 6-10. Memory Riser Card Connectors**

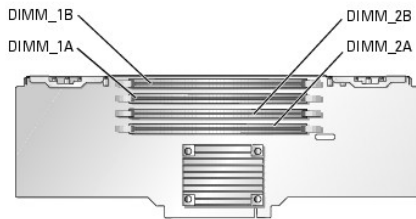

## General Memory Module Installation Guidelines

- 1 If only two memory modules are installed on a memory riser card, they must be installed in sockets DIMM\_1A and DIMM\_1B.
- 1 Two memory modules installed as a pair must have matched memory size, speed, and technology.
- 1 The system supports both single-ranked and dual-ranked memory modules.
- 1 If you install both single-ranked and dual-ranked memory modules, the dual-ranked memory modules must be installed in bank 1.

## Removing a Memory Riser Card Filler Blank

If you are adding an additional memory riser card, you will need to remove the filler blank installed in the location you are adding the new riser card. (The filler blanks are installed to direct cooling airflow if a memory riser is not installed.) To remove the filler blank, press the latch on the upper surface of the filler blank and slide the filler blank out of the system.

## Removing a Memory Riser Card Insulator

Each memory riser card has a plastic insulator that helps ventilate the memory modules. To remove the memory riser card insulator, lift the four tabs on the edges of the insulator. See [Figure 6-11](#).

**Figure 6-11. Removing and Installing a Memory Riser Card Insulator**

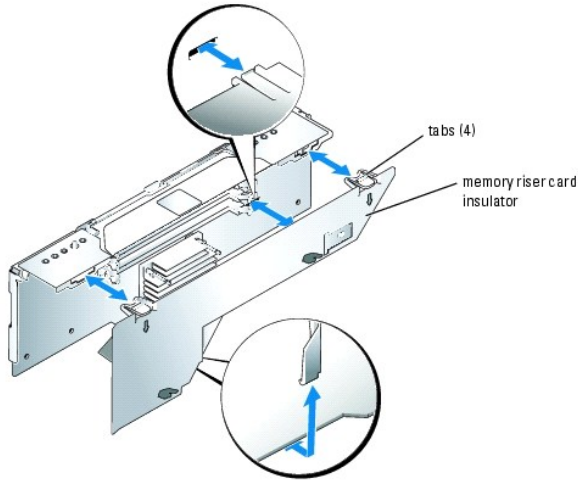

### Spare Bank Support

If four identical single-rank memory modules are installed on a memory riser card, two of the four modules in the same rank can function as a spare bank if you select the spare bank option using the System Setup program.

**NOTE:** Spare bank is not support between memory riser cards.

### Memory RAID Support

The system supports memory Redundant Array of Independent DIMMs (RAID) if identical memory modules are installed in riser cards A, B, C, and D (all four memory riser cards are required for memory RAID support). Memory RAID must be enabled in the System Setup program.

**NOTE:** Spare bank is not supported if memory RAID is enabled.

### Memory Mirroring Support

The system supports memory mirroring if identical memory modules are installed in riser card A and B or in riser card C and D (riser cards A and B are a mirror pair and riser cards C and D are a mirror pair). Mirroring must be enabled in the System Setup program.

**NOTE:** Spare bank is not supported if mirroring is enabled.

[Table 6-2](#) and [Table 6-3](#) show examples of different memory configurations. [Table 6-3](#) lists the various allowable combinations of single- and dual-ranked memory modules

**Table 6-2. Sample Memory Configurations per Memory Riser Card**

Total Memory	DIMM_1A	DIMM_1B	DIMM_2A	DIMM_2B
512 MB	256 MB	256 MB	none	none
1 GB	256 MB	256 MB	256 MB	256 MB
1 GB	512 MB	512 MB	none	none
2 GB	512 MB	512 MB	512 MB	512 MB
2 GB	1 GB	1 GB	none	none
3 GB	1 GB	1 GB	512 MB	512 MB
4 GB	1 GB	1 GB	1 GB	1 GB
6 GB	2 GB	2 GB	1 GB	1 GB
8 GB	2 GB	2 GB	2 GB	2 GB

**Table 6-3. Allowable Memory Module Configurations – Single-Ranked and Dual-Ranked Memory Modules**

DIMM_1A	DIMM_1B	DIMM_2A	DIMM_2B
Single rank	Single rank	none	none

Dual rank	Dual rank	none	none
Single rank	Single rank	Single rank	Single rank
Dual rank	Dual rank	Dual rank	Dual rank
Dual rank	Dual rank	Single rank	Single rank

## Removing and Installing a Hot-Pluggable Memory Riser Card

The following procedure explains how to safely remove and install a hot-pluggable memory riser card.

 **NOTE:** The system supports both hot-add and hot-replace memory upgrades.

 **CAUTION:** Many repairs may only be done by a certified service technician. You should only perform troubleshooting and simple repairs as authorized in your product documentation, or as directed by the online or telephone service and support team. Damage due to servicing that is not authorized by Dell is not covered by your warranty. Read and follow the safety instructions that came with the product.

1. Open the system. See "[Opening the System](#)" in "Troubleshooting Your System."
2. Verify that the memory riser card is operating in a hot-pluggable mode by ensuring that either the green "MIRROR" or the "RAID" mode indicator is lit. See [Figure 6-12](#) for the locations of the indicators on the memory riser card and see [Table 6-4](#) for a description of the indicators.
3. If you replacing a faulty memory module, identify the memory riser card that contains the faulty memory module.

If the amber attention indicator is on and the green power indicator is off, the memory riser card contains a faulty memory module. The location of the faulty module within the riser card is identified by the faulty module indicators labeled "1B," "1A," "2B," and "2A" on the memory riser card. See [Figure 6-12](#).

 **NOTICE:** Verify that the memory riser card is operating in a hot-pluggable mode by ensuring that either the green "MIRROR" or the "RAID" mode indicator is lit. See [Figure 6-12](#).

 **NOTICE:** Power off a memory riser card before removing it.

4. Press the power button on the memory riser card. See [Figure 6-12](#).

The amber attention indicator turns off and the green power indicator blinks while the riser card prepares for removal. See [Figure 6-12](#).

5. After the green power indicator stops blinking and turns off, remove the memory riser card:
  - a. Press in the release tab on the riser card handle. See [Figure 6-13](#).
  - b. Lift up the riser card handle and pull the riser card straight up.
  - c. Remove the plastic riser-card insulator. See "[Removing a Memory Riser Card Insulator](#)."
6. Add, remove, or replace a memory module, and then replace the insulator. See "[Installing Memory Modules](#)" or "[Removing Memory Modules](#)."
7. Install the memory riser card:
  - a. Ensure that the riser-card handle is fully extended, and then align both edges of the riser card with the front and rear riser-card guides. See [Figure 6-13](#).
  - b. Lower the riser card until the riser-card connector is near the riser-card connector on the system board.
  - c. Ensure that both connectors are properly aligned, and then gently press the riser card until it is fully seated.
  - d. Press down the riser-card handle until its release tab locks into place.

8. Press the power button on the memory riser card. See [Figure 6-12](#).

The green power indicator blinks while the system resynchronizes the riser card memory. See [Figure 6-12](#). After the green power indicator stops blinking and remains on, the memory is resynchronized.

 **NOTE:** It may take several minutes for the power indicator to stop blinking.

**Figure 6-12. Memory Riser Card Indicators and Features**

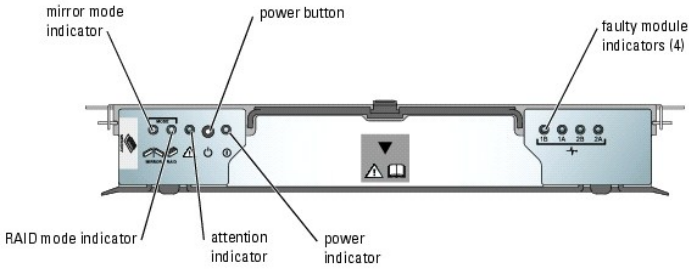

**Table 6-4. Memory Riser Card Indicators and Features**

Indicator or Button	Icon	Description
Mirror mode indicator		This indicator is green if system memory is configured in the System Setup program to operate in mirror mode and the mirrored memory riser card configuration is redundant. The memory riser card is hot-pluggable in mirror mode.  The indicator turns off if a mirrored memory riser card becomes disabled and is no longer redundant.
RAID mode indicator		This indicator is green if system memory is configured in the System Setup program to operate in RAID mode and the RAID memory riser card configuration is redundant. The memory riser card is hot-pluggable in RAID mode.  The indicator turns off if a memory riser card in the RAID configuration becomes disabled and is no longer redundant.
Attention indicator		This indicator is amber (and the green power indicator is off) if the memory riser card contains a faulty memory module or if a recovery error occurs while the riser card is being hot-replaced.
Power button		Powers the memory riser card on and off.
Power indicator		This indicator is green (and the amber attention indicator is off) if the memory riser card is powered on and all the memory modules are functioning normally.  This indicator is off (and the amber attention indicator is on) if the memory riser card is powered on but contains a faulty memory module.  This indicator is off (and the amber attention indicator is off) if the memory riser card is powered off and can be safely removed from the system.  Blinking green when the memory riser card is being powered down or powered up.

**Figure 6-13. Removing and Installing a Memory Riser Card**

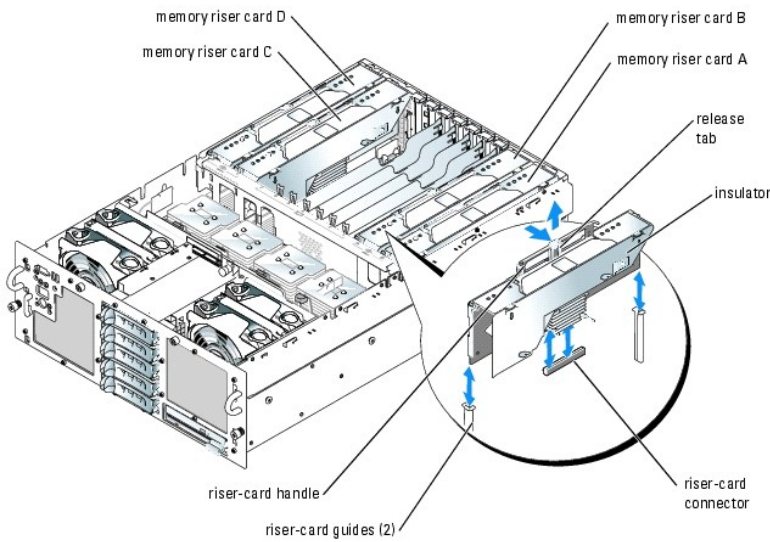

## Removing and Installing a Non-Hot-Pluggable Memory Riser Card

The following procedure explains how to safely remove and install a memory riser card that is operating in a non-hot-pluggable configuration.

**⚠ CAUTION:** Many repairs may only be done by a certified service technician. You should only perform troubleshooting and simple repairs as authorized in your product documentation, or as directed by the online or telephone service and support team. Damage due to servicing that is not authorized by Dell is not covered by your warranty. Read and follow the safety instructions that came with the product.

1. Turn off the system and attached peripherals, and disconnect the system from the electrical outlet.
2. Open the system. See "[Opening the System](#)" in "Troubleshooting Your System."
3. Remove the memory riser card:
  - a. Press in the release tab on the riser card handle. See [Figure 6-13](#).
  - b. Lift up the riser card handle and pull the riser card straight up.
  - c. Remove the plastic riser-card insulator. See "[Removing a Memory Riser Card Insulator](#)."
4. Add, remove, or replace a memory module, and then replace the insulator. See "[Installing Memory Modules](#)" or "[Removing Memory Modules](#)."
5. Install the memory riser card:
  - a. Ensure that the riser-card handle is fully extended, and then align both edges of the riser card with the front and rear riser-card guides. See [Figure 6-13](#).
  - b. Lower the riser card until the riser card connector is near the riser-card connector on the system board.
  - c. Ensure that both connectors are properly aligned, and then gently press the riser card until it is fully seated.
  - d. Press down the riser-card handle until its release tab locks into place.

## Installing Memory Modules

**⚠ CAUTION:** Many repairs may only be done by a certified service technician. You should only perform troubleshooting and simple repairs as authorized in your product documentation, or as directed by the online or telephone service and support team. Damage due to servicing that is not authorized by Dell is not covered by your warranty. Read and follow the safety instructions that came with the product.

1. If you are installing memory in a hot-pluggable memory operating environment, remove the memory riser card as described in "[Removing and Installing a Hot-Pluggable Memory Riser Card](#)."

If you are installing memory in a non-hot-pluggable memory operating environment, remove the memory riser card as described in "[Removing and Installing a Non-Hot-Pluggable Memory Riser Card](#)."

2. Locate the memory module sockets. See [Figure A-3](#).
3. Press the ejectors on the memory module socket down and out, as shown in [Figure 6-14](#), to allow the memory module to be inserted into the socket.

**Figure 6-14. Installing and Removing a Memory Module**

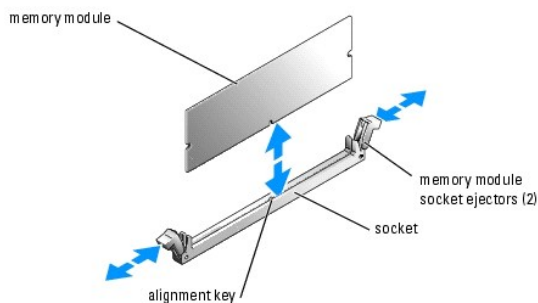

4. Align the memory module's edge connector with the alignment key on the memory module socket, and insert the memory module in the socket.

**🔍 NOTE:** The memory module socket has an alignment key that allows you to install the memory module in the socket in only one way.

5. Press down on the memory module with your thumbs while pulling up on the ejectors with your index fingers to lock the memory module into the socket.

When the memory module is properly seated in the socket, the ejectors on the memory module socket align with the ejectors on the other sockets that have memory modules installed.

- Repeat [step 2](#) through [step 5](#) of this procedure to install the remaining memory modules. See [Table 6-2](#) and [Table 6-3](#) for sample memory configurations.
- Install the memory riser card. See "[Removing and Installing a Hot-Pluggable Memory Riser Card](#)" or "[Removing and Installing a Non-Hot-Pluggable Memory Riser Card](#)."
- (Optional) Press <F2> to enter the System Setup program, and check the **System Memory** setting on the main **System Setup** screen.  
The system should have already changed the value to reflect the newly installed memory.
- If the value is incorrect, one or more of the memory modules may not be installed properly. Repeat [step 1](#) through [step 8](#) of this procedure, checking to ensure that the memory modules are firmly seated in their sockets.
- Run the system memory test in the system diagnostics. See "[Running the System Diagnostics](#)."

## Removing Memory Modules

**⚠ CAUTION:** Many repairs may only be done by a certified service technician. You should only perform troubleshooting and simple repairs as authorized in your product documentation, or as directed by the online or telephone service and support team. Damage due to servicing that is not authorized by Dell is not covered by your warranty. Read and follow the safety instructions that came with the product.

- If you are removing memory in a hot-pluggable memory operating environment, remove the memory riser card as described in "[Removing and Installing a Hot-Pluggable Memory Riser Card](#)."

If you are removing memory in a non-hot-pluggable memory operating environment, remove the memory riser card as described in "[Removing and Installing a Non-Hot-Pluggable Memory Riser Card](#)."

- Locate the memory module sockets. See [Figure A-3](#).
- Press down and out on the ejectors on each end of the socket until the memory module pops out of the socket. See [Figure 6-14](#).
- Install the memory riser card that you wish to upgrade. See "[Removing and Installing a Hot-Pluggable Memory Riser Card](#)."
- Close the system. See "[Closing the System](#)" in "Troubleshooting Your System."

---

## Processor

You can upgrade the system processor(s) to take advantage of future options in speed and functionality, or add additional processors. Each processor and its associated internal cache memory are contained in a pin grid array (PGA) package that is installed in a ZIF socket on the system board.

## Removing a Processor

**⚠ CAUTION:** Many repairs may only be done by a certified service technician. You should only perform troubleshooting and simple repairs as authorized in your product documentation, or as directed by the online or telephone service and support team. Damage due to servicing that is not authorized by Dell is not covered by your warranty. Read and follow the safety instructions that came with the product.

- Turn off the system and attached peripherals, and disconnect the system from the electrical outlet.
- Open the system. See "[Opening the System](#)" in "Troubleshooting Your System."
- Remove the cooling shroud. See "[Removing the Cooling Shroud](#)."

**🔧 NOTICE:** When you remove the heat sink, the possibility exists that the processor might adhere to the heat sink and be removed from the socket. It is recommended that you remove the heat sink while the processor is still warm.

**🔧 NOTICE:** Never remove the heat sink from a processor unless you intend to remove the processor. The heat sink is necessary to maintain proper thermal conditions.

- While pressing firmly on the blue tab on the end of the heat-sink retention clip, compress the sides of the retention clip together until the clip disengages from the slots in the socket, and then slide the retention clip forward to release it from the back clips. See [Figure 6-15](#).

Figure 6-15. Installing and Removing the Heat Sink

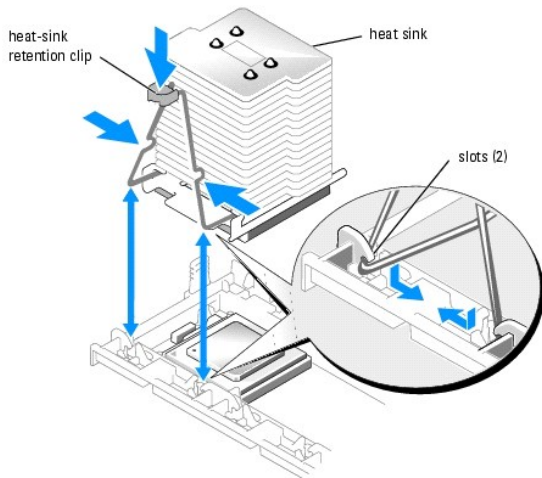

5. If the heat sink has not separated from the processor, carefully rotate the heat sink in a clockwise, then counterclockwise, direction until it releases from the processor. Do not pry the heat sink off of the processor.

➡ **NOTICE:** If you are going to reinstall the same processor and heat sink, ensure that you do not disturb the thermal grease on either the processor or the heat sink.

6. Lift the heat sink off of the processor and set the heat sink upside down so as not to contaminate the thermal grease.

7. Pull the socket-release lever straight up until the processor is released from the socket. See [Figure 6-16](#).

➡ **NOTICE:** If you are removing processor 1 or processor 3, pull upward on the blue plastic tab next to the socket to open the socket-release lever.

Figure 6-16. Installing and Removing a Processor

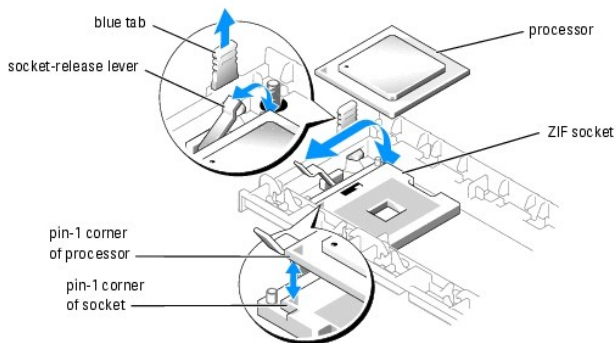

8. Lift the processor out of the socket and leave the release lever up so that the socket is ready for the new processor.

➡ **NOTICE:** Be careful not to bend any of the pins when removing the processor. Bending the pins can permanently damage the processor.

## Installing a Processor

⚠ **CAUTION:** Many repairs may only be done by a certified service technician. You should only perform troubleshooting and simple repairs as authorized in your product documentation, or as directed by the online or telephone service and support team. Damage due to servicing that is not authorized by Dell is not covered by your warranty. Read and follow the safety instructions that came with the product.

1. Turn off the system and attached peripherals, and disconnect the system from the electrical outlet.
2. Open the system. See "[Opening the System](#)" in "Troubleshooting Your System."
3. Remove the cooling shroud. See "[Removing the Cooling Shroud](#)."

4. Unpack the new processor.

If any of the pins on the processor appear bent, see ["Getting Help."](#)

5. If you are adding an additional processor, remove the processor filler blank from the socket by pressing inward on the two tabs on the filler blank and lifting the filler blank out of the system. See [Figure 6-17](#).

**Figure 6-17. Removing a Processor Filler Blank**

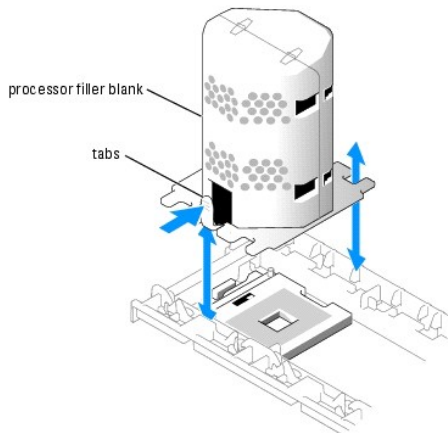

6. Align the pin-1 corner of the new processor with the pin-1 corner of the ZIF socket. See [Figure 6-16](#).

**NOTICE:** Identifying the pin-1 corners is critical to positioning the processor correctly. Pin-1 corners of processors 3 and 4 are opposite orientation of pin-1 corners of processors 1 and 2.

Identify the pin-1 corner of the processor by locating the tiny gold triangle on one corner of the processor. Place this corner in the same corner of the ZIF socket identified by a corresponding triangle.

7. Install the processor in the socket.

**NOTICE:** Positioning the processor incorrectly can permanently damage the processor and the system when you turn it on. When placing the processor in the socket, be sure that all of the pins on the processor enter the corresponding holes. Be careful not to bend the pins.

- a. If the release lever on the processor socket is not positioned all the way up, move it to that position.
- b. With the pin-1 corners of the processor and socket aligned, set the processor lightly in the socket, making sure all pins are matched with the correct holes in the socket.

Because the system uses a ZIF processor socket, do not use force, which could bend the pins if the processor is misaligned.

When the processor is positioned correctly, it drops down into the socket with minimal pressure.

- c. When the processor is fully seated in the socket, rotate the socket release lever back down until it snaps into place, securing the processor.

8. Install the heat sink.

- a. Using a clean lint-free cloth, remove the existing thermal grease from the heat sink.

**NOTE:** Use the heat sink that you removed in [step 6](#).

- b. Apply thermal grease evenly to the top of the processor.
- c. Place the heat sink onto the processor. See [Figure 6-15](#).
- d. Squeeze the sides of the heat-sink retention clip together and press down on the blue tab. When the lower corners of the clip fit into the slots in the socket, release the sides of the clip to lock the heat sink in place. See [Figure 6-15](#).

9. Reinstall the cooling shroud. See ["Installing the Cooling Shroud."](#)

10. Close the system. See ["Closing the System"](#) in "Troubleshooting Your System."

As the system boots, it detects the presence of the new processor and automatically changes the system configuration information in the System Setup program.

11. Press <F2> to enter the System Setup program, and check that the processor information matches the new system configuration.



See your *User's Guide* for instructions about using the System Setup program.

12. Run the system diagnostics to verify that the new processor operates correctly.

See "[Running the System Diagnostics](#)" for information about running the diagnostics and troubleshooting processor problems.

## Installing A Processor VRM

The voltage regulator modules (VRMs) for Processor 1 and Processor 2 are installed on the system board. If you add a third and fourth processor, you must also install a VRM for each additional processor.

**⚠ CAUTION:** Many repairs may only be done by a certified service technician. You should only perform troubleshooting and simple repairs as authorized in your product documentation, or as directed by the online or telephone service and support team. Damage due to servicing that is not authorized by Dell is not covered by your warranty. Read and follow the safety instructions that came with the product.

1. Turn off the system, including any attached peripherals, and disconnect the system from the electrical outlet.
2. Open the system. See "[Opening the System](#)" in "Troubleshooting Your System."
3. Locate the VRM socket for the processor you have added. See [Figure A-3](#).
4. Press the ejectors on the VRM socket down and out, as shown in [Figure 6-18](#), to allow the VRM to be inserted into the socket.

**Figure 6-18. Installing a VRM**

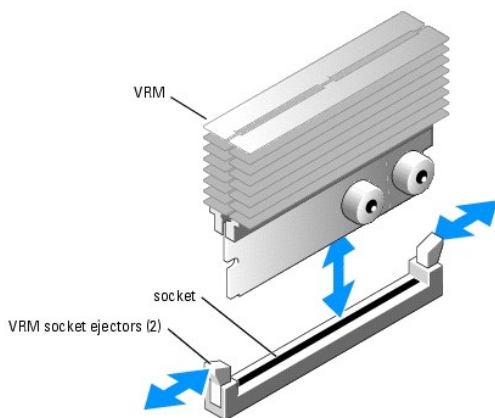

5. Align the VRM's edge connector with the alignment key on the socket, and insert the VRM in the socket. See [Figure 6-18](#).

**🔧 NOTE:** The socket has an alignment key that allows you to install the VRM in the socket in only one way.

6. Press down on the VRM with your thumbs while pulling up on the ejectors with your index fingers to lock the VRM into the socket.
7. Close the system. See "[Closing the System](#)" in "Troubleshooting Your System."
8. Reconnect the system and peripherals to their power sources, and turn them on.

## Installing Drives

### Dell™ PowerEdge™ 6850 Systems Installation and Troubleshooting Guide

- [Installing SCSI Hard Drives](#)
- [Installing a Diskette Drive](#)
- [Installing an Optical Drive](#)
- [Connecting an External SCSI Tape Drive](#)
- [Configuring the Boot Drive](#)
- [SCSI Backplane Daughter Card](#)
- [Activating the Optional Integrated RAID Controller](#)
- [Installing a RAID Controller Card](#)
- [SCSI Hard-Drive Cabling Guidelines](#)

Your system features five standard internal hard-drive bays that accommodate up to five 3.5-inch SCSI hard drives. Systems with an optional RAID controller card or optional ROMB support hot-plug SCSI drive operation.

The system's peripheral bay can accommodate a removable drive carrier that supports an optional diskette drive and optional optical drive.

---

## Installing SCSI Hard Drives

[Figure 7-1](#) shows the SCSI ID numbers of the five standard drive bays.

Figure 7-1. Hard-Drive SCSI ID Numbers

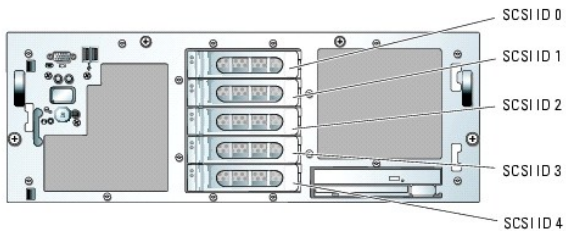

### Before You Begin

SCSI hard drives are supplied in special drive carriers that fit in the hard-drive bays.

- ➡ **NOTICE:** Before attempting to remove or install a drive while the system is running, see the documentation for the optional RAID controller card or optional ROMB to ensure that the host adapter is configured correctly to support hot-plug drive removal and insertion.
- 📌 **NOTE:** It is recommended that you use only drives that have been tested and approved for use with the SCSI backplane board.

You may need to use different programs than those provided with the operating system to partition and format SCSI hard drives.

- ➡ **NOTICE:** Do not turn off or reboot your system while the drive is being formatted. Doing so can cause a drive failure.

When you format a high-capacity SCSI hard drive, allow enough time for the formatting to be completed. Long format times for these drives are normal. A 9-GB hard drive, for example, can take up to 2.5 hours to format.

### Installing a SCSI Hard Drive

- ➡ **NOTICE:** Hot-plug drive installation is not supported for systems without an optional RAID controller card or optional ROMB.

1. If the system does not have an optional RAID controller card or optional integrated ROMB, shut down the system.
2. Remove the front bezel, if attached. See "[Opening the System](#)" in "Troubleshooting Your System."
3. Open the hard-drive handle. See [Figure 7-2](#).

Figure 7-2. Installing a SCSI Hard Drive

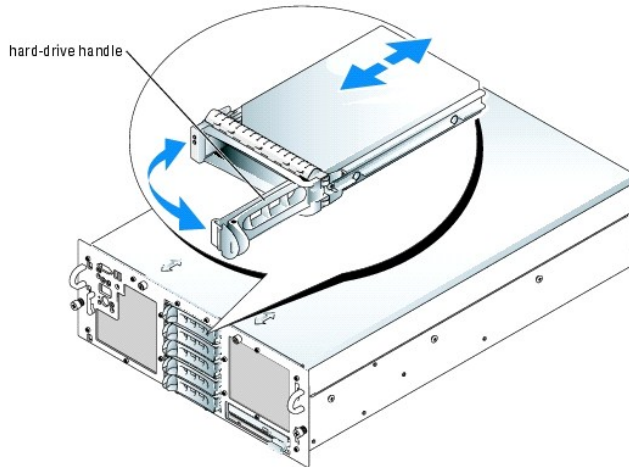

4. Insert the hard drive into the drive bay. See [Figure 7-2](#).
5. Close the hard-drive handle to lock the drive in place.
6. Replace the front bezel, if it was removed in [step 2](#).
7. If the hard drive is a new drive, run the **SCSI Controllers** test in the system diagnostics.

## Removing a SCSI Hard Drive

**NOTICE:** Hot-plug drive removal is not supported for systems without an optional RAID controller card or optional ROMB. Hot-plug capabilities must also be enabled when using an optional RAID controller card or optional ROMB.

1. If the system does not have an optional RAID controller card or optional ROMB, shut down the system.
2. Remove the front bezel, if attached. See "[Opening the System](#)" in "Troubleshooting Your System."
3. For systems with a RAID controller card or ROMB, power down the hard-drive bay and wait until the SCSI hard-drive indicators on the drive carrier signal that the drive can be removed safely.  
  
If the drive has been online, the green power-on/fault indicator flashes as the drive is preparing for removal. When the indicator is off, the drive is ready for removal.
4. Open the hard-drive handle to release the drive.
5. Slide the hard drive out until it is free of the drive bay.
6. Replace the front bezel, if it was removed in [step 2](#).

## Installing a Diskette Drive

**CAUTION:** Many repairs may only be done by a certified service technician. You should only perform troubleshooting and simple repairs as authorized in your product documentation, or as directed by the online or telephone service and support team. Damage due to servicing that is not authorized by Dell is not covered by your warranty. Read and follow the safety instructions that came with the product.

1. Turn off the system, including any attached peripherals, and disconnect the system from the electrical outlet.
2. Remove the front bezel, if attached. See "[Opening the System](#)" in "Troubleshooting Your System."
3. To remove the drive carrier, pull the release latch forward, then slide the carrier out of the chassis. See [Figure 7-3](#).

**Figure 7-3. Installing and Removing the Diskette/Optical Drive Carrier**

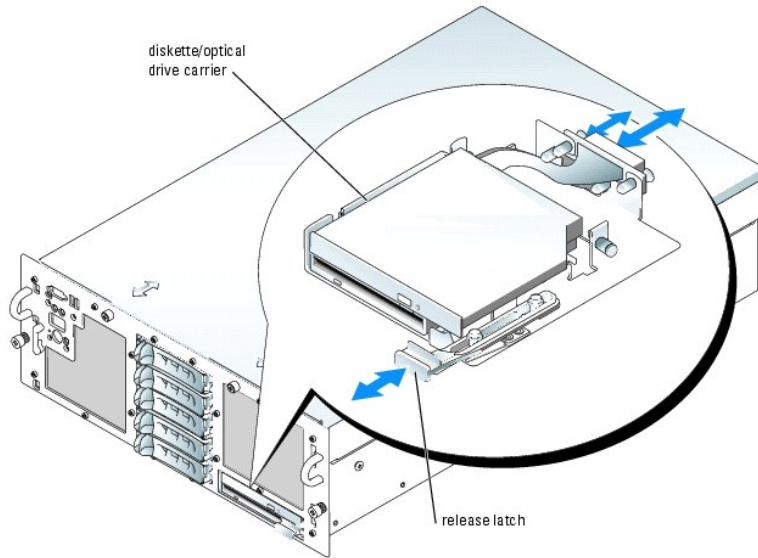

4. Remove the optical drive or optical drive filler plate from the carrier:
  - a. Loosen the thumbscrew on the latch securing the optical drive or filler plate. See [Figure 7-4](#).
  - b. Remove the latch.
  - c. Lift the optical drive or optical drive filler plate from the carrier.

**Figure 7-4. Installing a Diskette Drive in the Drive Carrier**

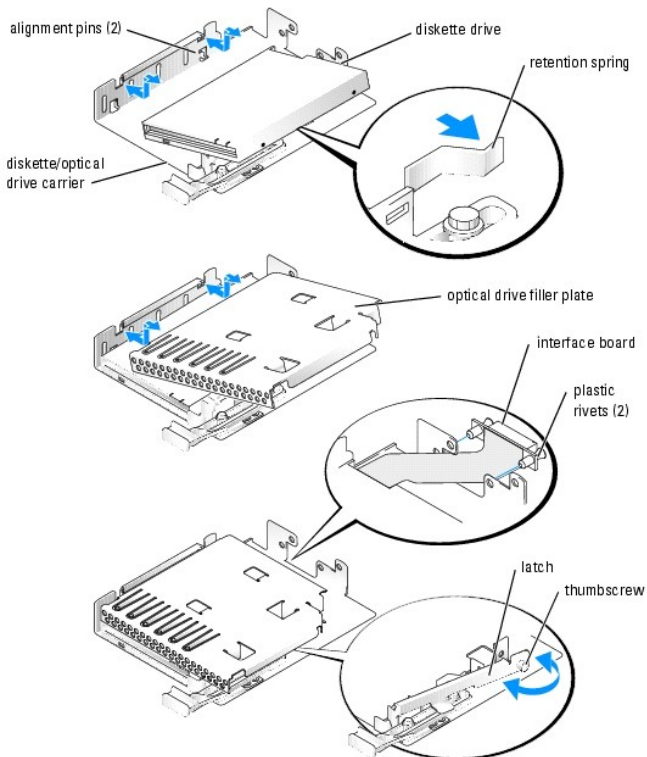

5. To remove the diskette drive filler plate, pull the retention spring slightly away from the filler plate, then lift the filler plate from the carrier.
6. Deflect the retention spring slightly, then insert the diskette drive into the carrier.

The pins on the carrier fit into the corresponding holes in the side of the drive. See [Figure 7-4](#).

7. Replace the optical drive or optical drive filler plate in the carrier.

The pins on the carrier fit into the corresponding holes in the side of the drive.

8. Reinstall the latch and tighten the thumbscrew.
9. Replace the front bezel, if it was removed in [step 2](#). See "[Closing the System](#)" in "Troubleshooting Your System."
10. Reconnect the system and peripherals to their electrical outlets.

---

## Installing an Optical Drive

**⚠ CAUTION:** Many repairs may only be done by a certified service technician. You should only perform troubleshooting and simple repairs as authorized in your product documentation, or as directed by the online or telephone service and support team. Damage due to servicing that is not authorized by Dell is not covered by your warranty. Read and follow the safety instructions that came with the product.

1. Turn off the system, including any attached peripherals, and disconnect the system from the electrical outlet.
2. Remove the front bezel, if attached. See "[Opening the System](#)" in "Troubleshooting Your System."
3. To remove the drive carrier, pull the release latch forward, then slide the carrier out of the chassis. See [Figure 7-3](#).
4. Remove the optical drive filler plate from the carrier:
  - a. Loosen the thumbscrew from the latch securing the optical drive or filler plate. See [Figure 7-5](#).
  - b. Remove the latch.
  - c. Lift the optical drive filler plate from the carrier.

**Figure 7-5. Installing an Optical Drive in the Drive Carrier**

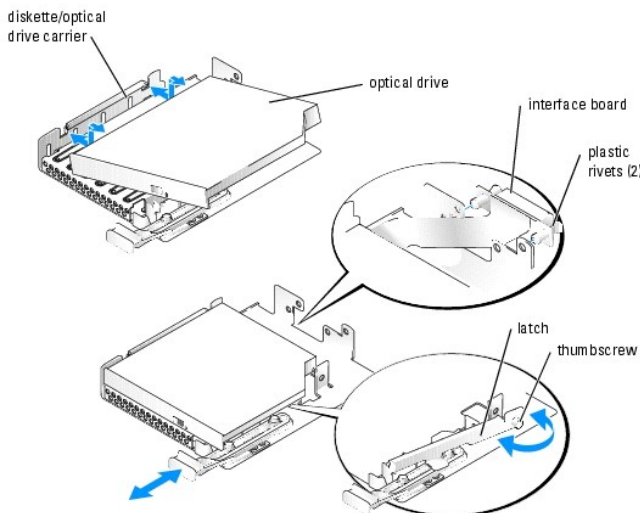

5. Install the new optical drive in the carrier. See [Figure 7-5](#).

The pins on the carrier fit into the corresponding holes in the side of the drive.
6. Attach the interface board to the back of the carrier, using the two plastic rivets. See [Figure 7-5](#).
7. Reinstall the latch and tighten the thumbscrew.
8. Close the system. See "[Closing the System](#)" in "Troubleshooting Your System."
9. Replace the front bezel, if it was removed in [step 2](#). See "[Closing the System](#)" in "Troubleshooting Your System."

10. Reconnect the system and peripherals to their electrical outlets.
- 

## Connecting an External SCSI Tape Drive

This subsection describes how to configure and install an external SCSI tape drive. The drive may be connected to the integrated SCSI controller using the SCSI connector on the system back panel, or to an optional SCSI controller card.

**⚠ CAUTION:** Many repairs may only be done by a certified service technician. You should only perform troubleshooting and simple repairs as authorized in your product documentation, or as directed by the online or telephone service and support team. Damage due to servicing that is not authorized by Dell is not covered by your warranty. Read and follow the safety instructions that came with the product.

1. Turn off the system, including any attached peripherals, and disconnect the system from the electrical outlet.
  2. Remove the front bezel, if attached. See "[Opening the System](#)" in "Troubleshooting Your System."
  3. Open the system. See "[Opening the System](#)" in "Troubleshooting Your System."
  4. Ground yourself by touching an unpainted metal surface on the back of the system, unpack the drive, and compare the jumper and switch settings with those in the documentation that came with the drive.
  5. Unpack the tape drive (and controller card, if applicable) and configure the tape drive according to the documentation that came with the tape drive, based on the following guidelines:
    - a. Each device attached to a SCSI host adapter must have a unique SCSI ID number. (Narrow SCSI devices use IDs 0 to 7; wide SCSI devices use IDs from 0 to 15). Set the drive's SCSI ID to avoid conflicts with other devices on the SCSI bus. For the default SCSI ID setting, see the documentation provided with the drive.
- 📌 NOTE:** There is no requirement that SCSI ID numbers be assigned sequentially or that devices be attached to the cable in order by ID number.
- b. SCSI logic requires that the two devices at opposite ends of a SCSI chain be terminated and that all devices in between be unterminated. Therefore, you enable the tape drive's termination if it is the last device in a chain of devices (or sole device) connected to the SCSI controller.
6. If you are connecting the drive to a controller card, install the controller card in an expansion slot. See "[Installing an Expansion Card](#)" in "Installing System Components."
  7. Connect the tape drive's SCSI interface cable to the drive.
  8. Connect the other end of the SCSI interface cable to the SCSI controller card, or the external SCSI connector on the system's back panel (see [Figure 2-2](#)).
  9. Connect the tape drive's power cable to an electrical outlet.
  10. Close the system. See "[Closing the System](#)" in "Troubleshooting Your System."
  11. Replace the front bezel, if it was removed in [step 2](#). See "[Closing the System](#)" in "Troubleshooting Your System."
  12. Reconnect the system and peripherals to their electrical outlets, and turn them on.
  13. Perform a tape backup and verification test with the drive as instructed in the software documentation that came with the drive.
- 

## Configuring the Boot Drive

The drive or device from which the system boots is determined by the boot order specified in the System Setup program. See "Using the System Setup Program" in your *User's Guide*.

---

## SCSI Backplane Daughter Card

### Removing the SCSI Backplane Board

**⚠ CAUTION:** Many repairs may only be done by a certified service technician. You should only perform troubleshooting and simple repairs as authorized in your product documentation, or as directed by the online or telephone service and support team. Damage due to servicing that is not authorized by Dell is not covered by your warranty. Read and follow the safety instructions that came with the product.

1. Turn off the system and attached peripherals, and disconnect the system from the electrical outlet.
2. Open the system. See "[Opening the System](#)" in "Troubleshooting Your System."
3. Remove the cooling shroud. See "[Removing the Cooling Shroud](#)" in "Installing System Components."
- ➡ **NOTICE:** To prevent damage to the drives and backplane, you must remove the SCSI drives and diskette/optical drive carrier from the system before removing the backplane. You must note the number of each hard drive and temporarily label them before removal, so you can replace them in the same locations.
4. Unlock and slide the SCSI hard drive(s) out of the system. See "[Removing a SCSI Hard Drive](#)."
5. Remove the diskette/optical drive carrier. See [Figure 7-3](#).
6. Remove the processor filler blanks or heat sinks from processors 2 and 4. See "[Processor](#)" in "Installing System Components."
7. Disconnect the SCSI, data interface, and power cables from the front of the SCSI backplane. See [Figure A-5](#).
- ➡ **NOTICE:** When disconnecting the control-panel cable, hold the white pull-tab next to the control-panel cable connector to prevent damage to the SCSI backplane or the cable itself.
8. Disconnect the control-panel cable from the back of the SCSI backplane. See [Figure A-5](#).
9. Remove the SCSI backplane:
  - a. Pull the spring-loaded blue retention pin away from the front of the backplane, then slide the backplane upward. See [Figure 7-6](#).
  - b. When the backplane cannot slide upward any farther, pull the backplane toward the back of the system to remove it from the retention hooks.
  - c. Lift the board out of the system, being careful to avoid damaging components on the face of the board.
  - d. Place the SCSI backplane face down on a work surface.

**Figure 7-6. Removing and Installing the SCSI Backplane**

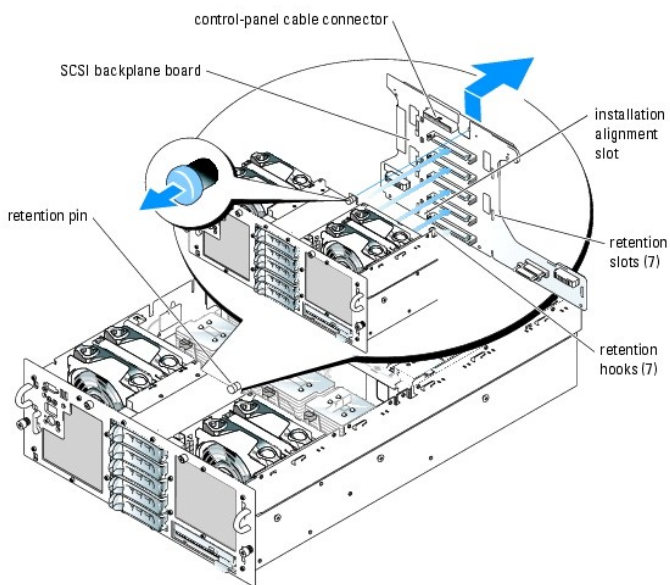

## Installing the SCSI Daughter Card

1. Hold the daughter card by its edges with the card connector facing the SCSI backplane board.
2. Insert the card connector into the daughter card connector on the SCSI backplane board. See [Figure 7-7](#). Ensure that the standoffs on the daughter card are fully seated into the SCSI backplane board.

**Figure 7-7. Installing and Removing the SCSI Backplane Daughter Card**

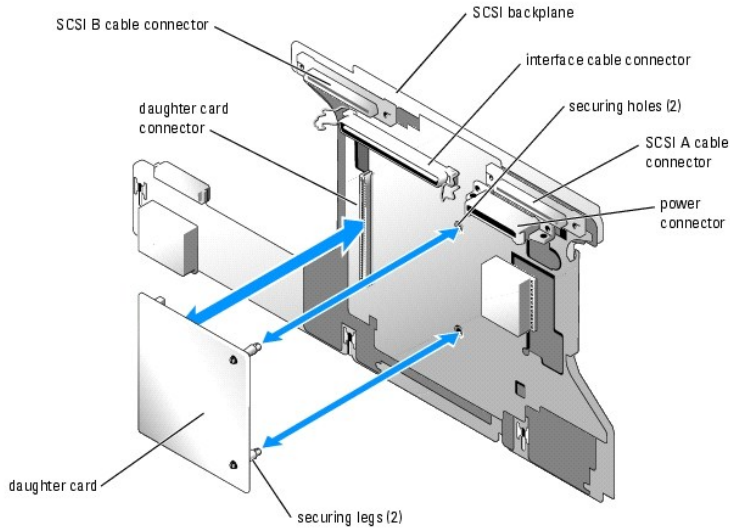

## Reinstalling the SCSI Backplane Board

1. Install the backplane board. See [Figure 7-6](#).
  - a. Slowly lower the backplane into the system, being careful to avoid damaging components on the face of the board.
  - b. Align the installation alignment slot on the bottom of the backplane with the alignment pin on the bottom of the chassis.
  - c. Slide the retention slots on the backplane over the retention hooks on the chassis.
  - d. Slide the backplane downward until the blue retention pin snaps into place.
2. Connect the SCSI, data interface, and power cables to the front of the SCSI backplane. See [Figure A-5](#).
3. Connect the control panel cable to the back of the SCSI backplane. See [Figure A-5](#).
4. Replace the processor filler blanks or heat sinks on processors 2 and 4. See "[Processor](#)" in "Installing System Components."
5. Reinstall the SCSI hard drives in their original locations. See "[Installing a SCSI Hard Drive](#)."
6. Replace the diskette/optical drive carrier. See [Figure 7-3](#).
7. Replace the cooling shroud. See "[Installing the Cooling Shroud](#)."
8. Replace the cover. See "[Closing the System](#)."
9. Reconnect the system to its electrical outlet and turn the system on, including any attached peripherals.
10. If applicable, reattach the bezel.

## Activating the Optional Integrated RAID Controller

This subsection explains how to activate your system's integrated RAID controller.

**CAUTION:** Many repairs may only be done by a certified service technician. You should only perform troubleshooting and simple repairs as authorized in your product documentation, or as directed by the online or telephone service and support team. Damage due to servicing that is not authorized by Dell is not covered by your warranty. Read and follow the safety instructions that came with the product.

**CAUTION:** Replace the battery only with the same or equivalent type recommended by the manufacturer. Discard used batteries according to the manufacturer's instructions. See your *Product Information Guide* for additional information.

**NOTICE:** To avoid possible data loss, back up all data on the hard drives before changing the mode of operation of the integrated SCSI controller from SCSI to RAID.

1. Turn off the system, including any attached peripherals, and disconnect the system from the electrical outlet.



2. Remove the cover. See "[Opening the System.](#)"
3. Remove the memory filler blank or the memory riser card from memory slot C. See "[Removing and Installing a Non-Hot-Pluggable Memory Riser Card.](#)"
4. Insert the RAID hardware key into its connector on the system board and secure the key with the latches on each end of the connector. See [Figure 7-8](#) and [Figure A-3](#).

**Figure 7-8. Activating the Integrated RAID Controller**

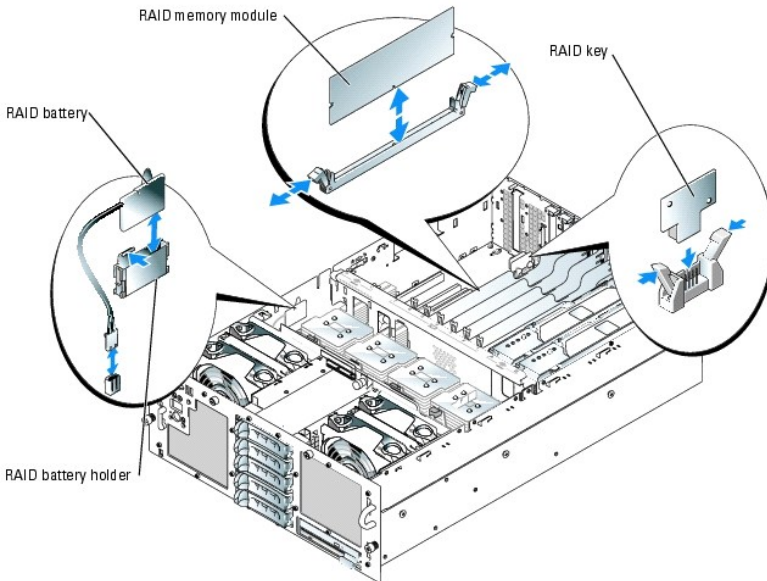

5. Locate the RAID memory module connector on the system board. See [Figure 7-8](#) and [Figure A-3](#).
  6. Push the ejectors on the RAID memory module connector outward to allow the memory module to be inserted into the connector.
  7. Align the RAID memory module's edge connector with the alignment keys, and insert the memory module into the connector.
- NOTE:** Do not substitute registered memory modules such as those used for system memory. Use the memory module supplied in the RAID upgrade kit.
8. Press on the memory module with your thumbs while closing the ejectors with your index fingers to lock the memory module into the connector.
  9. Insert the RAID battery into the battery holder. See [Figure 7-8](#).
  10. Connect the battery power cable to the RAID battery cable connector on the system board. See [Figure A-4](#).
  11. Replace the memory filler blank or the memory riser card in memory slot C. See "[Removing and Installing a Non-Hot-Pluggable Memory Riser Card.](#)"
  12. Replace the cover. See "[Closing the System.](#)"
  13. Reconnect the system to its electrical outlet and turn the system on, including any attached peripherals.
  14. Enter the System Setup program and verify that the setting for the SCSI controller has changed to reflect the presence of the RAID hardware. See "Using the System Setup Program" in your *User's Guide*.
  15. Install and configure the RAID software.

See the RAID software documentation for more information.

## Installing a RAID Controller Card

See "[Installing an Expansion Card](#)" in "Installing System Components" for instructions about installing the card. See the RAID controller documentation for information on installing and configuring the RAID software.

---

## SCSI Hard-Drive Cabling Guidelines

### Non-RAID Configurations

For a system without an optional RAID controller installed, connect SCSI channel A on the system board to connector SCSI A on the SCSI backplane board. If the optional external SCSI cable is installed, connect it to SCSI channel B on the system board.

### RAID Configurations

If the optional ROMB controller is enabled, or an optional RAID controller card is installed, you can configure the hard drives for RAID operation. The general cabling configurations for various system options are discussed in the following subsections. For details on drive requirements for specific RAID types, see your RAID controller documentation.

#### 1+5 Drive Configuration

For a 1+5 drive configuration, connect SCSI channel A on the system board (see [Figure A-4](#)) or SCSI channel A on the optional RAID card to connector SCSI A on the 1+5 backplane (see [Figure A-5](#)). Drive 0 functions as the boot drive.

#### 2+3 Split Backplane Configurations

 **NOTICE:** An optional daughter card must be installed on the back of the 1+5 SCSI backplane to support split 2+3 backplane operation.

- 1 To use the optional integrated ROMB controller in a split 2+3 backplane configuration:
  - o Connect SCSI channel A on the system board (see [Figure A-3](#)) to connector SCSI A on the SCSI backplane (see [Figure A-5](#)). This channel controls the boot drive (drive 0) and drives 1 and 2.
  - o Connect SCSI channel B on the system board (see [Figure A-3](#)) to connector SCSI B on the SCSI backplane (see [Figure A-5](#)). This channel controls drives 3 and 4.
- 1 To use an optional RAID controller card in a split 2+3 backplane configuration:
  - o Connect SCSI channel A (channel 0) on the controller card to connector SCSI A on the SCSI backplane (see [Figure A-5](#)). This channel controls the boot drive (drive 0) and drives 1 and 2.
  - o Connect SCSI channel B (channel 1) on the controller card to connector SCSI B on the SCSI backplane (see [Figure A-5](#)). This channel controls drives 3 and 4.

---

[Back to Contents Page](#)

[Back to Contents Page](#)

## Getting Help

### Dell™ PowerEdge™ 6850 Systems Installation and Troubleshooting Guide

- [Technical Assistance](#)
  - [Dell Enterprise Training and Certification](#)
  - [Problems With Your Order](#)
  - [Product Information](#)
  - [Returning Items for Warranty Repair or Credit](#)
  - [Before You Call](#)
  - [Contacting Dell](#)
- 

## Technical Assistance

If you need assistance with a technical problem, perform the following steps:

1. Complete the procedures in "[Troubleshooting Your System](#)."
2. Run the system diagnostics and record any information provided.
3. Make a copy of the [Diagnostics Checklist](#), and fill it out.
4. Use Dell's extensive suite of online services available at Dell Support at [support.dell.com](http://support.dell.com) for help with installation and troubleshooting procedures.

For more information, see "[Online Services](#)."

5. If the preceding steps have not resolved the problem, call Dell for technical assistance.

**NOTE:** Call technical support from a phone near or at the system so that technical support can assist you with any necessary procedures.

**NOTE:** Dell's Express Service Code system may not be available in all countries.

When prompted by Dell's automated telephone system, enter your Express Service Code to route the call directly to the proper support personnel. If you do not have an Express Service Code, open the **Dell Accessories** folder, double-click the **Express Service Code** icon, and follow the directions.

For instructions on using the technical support service, see "[Technical Support Service](#)" and "[Before You Call](#)."

**NOTE:** Some of the following services are not always available in all locations outside the continental U.S. Call your local Dell representative for information on availability.

## Online Services

You can access Dell Support at [support.dell.com](http://support.dell.com). Select your region on the **WELCOME TO DELL SUPPORT** page, and fill in the requested details to access help tools and information.

You can contact Dell electronically using the following addresses:

- 1 World Wide Web

[www.dell.com/](http://www.dell.com/)

[www.dell.com/ap/](http://www.dell.com/ap/) (Asian/Pacific countries only)

[www.dell.com/jp](http://www.dell.com/jp/) (Japan only)

[www.euro.dell.com](http://www.euro.dell.com) (Europe only)

[www.dell.com/la](http://www.dell.com/la/) (Latin American countries)

[www.dell.ca](http://www.dell.ca) (Canada only)

- 1 Anonymous file transfer protocol (FTP)

[ftp.dell.com/](ftp://ftp.dell.com/)

Log in as user:anonymous, and use your e-mail address as your password.

- 1 Electronic Support Service

[support@us.dell.com](mailto:support@us.dell.com)

[apsupport@dell.com](mailto:apsupport@dell.com) (Asian/Pacific countries only)

**support.jp.dell.com** (Japan only)

**support.euro.dell.com** (Europe only)

1 Electronic Quote Service

sales@dell.com

apmarketing@dell.com (Asian/Pacific countries only)

sales\_canada@dell.com (Canada only)

1 Electronic Information Service

info@dell.com

## AutoTech Service

Dell's automated technical support service—AutoTech—provides recorded answers to the questions most frequently asked by Dell customers about their portable and desktop computer systems.

When you call AutoTech, use your touch-tone telephone to select the subjects that correspond to your questions.

The AutoTech service is available 24 hours a day, 7 days a week. You can also access this service through the technical support service. See the contact information for your region.

## Automated Order-Status Service

To check on the status of any Dell™ products that you have ordered, you can go to **support.dell.com**, or you can call the automated order-status service. A recording prompts you for the information needed to locate and report on your order. See the contact information for your region.

## Technical Support Service

Dell's technical support service is available 24 hours a day, 7 days a week, to answer your questions about Dell hardware. Our technical support staff use computer-based diagnostics to provide fast, accurate answers.

To contact Dell's technical support service, see "[Before You Call](#)" and then see the contact information for your region.

---

## Dell Enterprise Training and Certification

Dell Enterprise Training and Certification is available; see [www.dell.com/training](http://www.dell.com/training) for more information. This service may not be offered in all locations.

---

## Problems With Your Order

If you have a problem with your order, such as missing parts, wrong parts, or incorrect billing, contact Dell for customer assistance. Have your invoice or packing slip available when you call. See the contact information for your region.

---

## Product Information

If you need information about additional products available from Dell, or if you would like to place an order, visit the Dell website at [www.dell.com](http://www.dell.com). For the telephone number to call to speak to a sales specialist, see the contact information for your region.

---

## Returning Items for Warranty Repair or Credit

Prepare all items being returned, whether for repair or credit, as follows:

1. Call Dell to obtain a Return Material Authorization Number, and write it clearly and prominently on the outside of the box.

For the telephone number to call, see the contact information for your region.

2. Include a copy of the invoice and a letter describing the reason for the return.

3. Include a copy of any diagnostic information (including the Diagnostics Checklist) indicating the tests you have run and any error messages reported by

the system diagnostics.

4. Include any accessories that belong with the item(s) being returned (such as power cables, media such as CDs and diskettes, and guides) if the return is for credit.
5. Pack the equipment to be returned in the original (or equivalent) packing materials.

You are responsible for paying shipping expenses. You are also responsible for insuring any product returned, and you assume the risk of loss during shipment to Dell. Collect-on-delivery (C.O.D.) packages are not accepted.

Returns that are missing any of the preceding requirements will be refused at our receiving dock and returned to you.

---

## Before You Call

**NOTE:** Have your Express Service Code ready when you call. The code helps Dell's automated-support telephone system direct your call more efficiently.

Remember to fill out the [Diagnostics Checklist](#). If possible, turn on your system before you call Dell for technical assistance and call from a telephone at or near the computer. You may be asked to type some commands at the keyboard, relay detailed information during operations, or try other troubleshooting steps possible only at the computer system itself. Ensure that the system documentation is available.

 **CAUTION:** Before servicing any components inside your computer, see your *Product Information Guide* for important safety information.

Diagnostics Checklist
Name:
Date:
Address:
Phone number:
Service Tag (bar code on the back of the computer):
Express Service Code:
Return Material Authorization Number (if provided by Dell support technician):
Operating system and version:
Peripherals:
Expansion cards:
Are you connected to a network? Yes No
Network, version, and network card:
Programs and versions:
See your operating system documentation to determine the contents of the system's start-up files. If possible, print each file. Otherwise, record the contents of each file before calling Dell.
Error message, beep code, or diagnostic code:
Description of problem and troubleshooting procedures you performed:

---

## Contacting Dell

To contact Dell electronically, you can access the following websites:

- 1 [www.dell.com](http://www.dell.com)
- 1 [support.dell.com](http://support.dell.com) (technical support)
- 1 [premiersupport.dell.com](http://premiersupport.dell.com) (technical support for educational, government, healthcare, and medium/large business customers, including Premier, Platinum, and Gold customers)

For specific web addresses for your country, find the appropriate country section in the table below.

**NOTE:** Toll-free numbers are for use within the country for which they are listed.

When you need to contact Dell, use the electronic addresses, telephone numbers, and codes provided in the following table. If you need assistance in determining which codes to use, contact a local or an international operator.

---

--	--	--

Country (City) International Access Code Country Code City Code	Department Name or Service Area, Website and E-Mail Address	Area Codes, Local Numbers, and Toll-Free Numbers
<b>Anguilla</b>	General Support	toll-free: 800-335-0031
<b>Antigua and Barbuda</b>	General Support	1-800-805-5924
<b>Argentina (Buenos Aires)</b>  International Access Code: <b>00</b>  Country Code: <b>54</b>  City Code: <b>11</b>	Website: <a href="http://www.dell.com.ar">www.dell.com.ar</a>	
	E-mail: <a href="mailto:us_latin_services@dell.com">us_latin_services@dell.com</a>	
	E-mail for desktop and portable computers: <a href="mailto:la-techsupport@dell.com">la-techsupport@dell.com</a>	
	E-mail for servers and EMC: <a href="mailto:la_enterprise@dell.com">la_enterprise@dell.com</a>	
	Customer Care	toll-free: 0-800-444-0730
	Tech Support	toll-free: 0-800-444-0733
	Tech Support Services	toll-free: 0-800-444-0724
	Sales	0-810-444-3355
<b>Aruba</b>	General Support	toll-free: 800-1578
<b>Australia (Sydney)</b>  International Access Code: <b>0011</b>  Country Code: <b>61</b>  City Code: <b>2</b>	E-mail (Australia): <a href="mailto:au_tech_support@dell.com">au_tech_support@dell.com</a>	
	E-mail (New Zealand): <a href="mailto:nz_tech_support@dell.com">nz_tech_support@dell.com</a>	
	Home and Small Business	1-300-655-533
	Government and Business	toll-free: 1-800-633-559
	Preferred Accounts Division (PAD)	toll-free: 1-800-060-889
	Customer Care	toll-free: 1-800-819-339
	Technical Support (portables and desktops)	toll-free: 1-300-655-533
	Technical Support (servers and workstations)	toll-free: 1-800-733-314
	Corporate Sales	toll-free: 1-800-808-385
	Transaction Sales	toll-free: 1-800-808-312
	Fax	toll-free: 1-800-818-341
<b>Austria (Vienna)</b>  International Access Code: <b>900</b>  Country Code: <b>43</b>  City Code: <b>1</b>	Website: <a href="http://support.euro.dell.com">support.euro.dell.com</a>	
	E-mail: <a href="mailto:tech_support_central_europe@dell.com">tech_support_central_europe@dell.com</a>	
	Home/Small Business Sales	0820 240 530 00
	Home/Small Business Fax	0820 240 530 49
	Home/Small Business Customer Care	0820 240 530 14
	Preferred Accounts/Corporate Customer Care	0820 240 530 16
	Home/Small Business Technical Support	0820 240 530 14
	Preferred Accounts/Corporate Technical Support	0660 8779
	Switchboard	0820 240 530 00
<b>Bahamas</b>	General Support	toll-free: 1-866-278-6818
<b>Barbados</b>	General Support	1-800-534-3066
<b>Belgium (Brussels)</b>  International Access Code: <b>00</b>  Country Code: <b>32</b>  City Code: <b>2</b>	Website: <a href="http://support.euro.dell.com">support.euro.dell.com</a>	
	E-mail for French-speaking Customers: <a href="http://support.euro.dell.com/be/fr/emaildell/">support.euro.dell.com/be/fr/emaildell/</a>	
	Technical Support	02 481 92 88
	Technical Support Fax	02 481 92 95
	Customer Care	02 713 15 .65
	Corporate Sales	02 481 91 00
	Fax	02 481 92 99
	Switchboard	02 481 91 00
<b>Bermuda</b>	General Support	1-800-342-0671
<b>Bolivia</b>	General Support	toll-free: 800-10-0238
<b>Brazil</b>  International Access Code: <b>00</b>  Country Code: <b>55</b>  City Code: <b>51</b>	Website: <a href="http://www.dell.com/br">www.dell.com/br</a>	
	Customer Support, Technical Support	0800 90 3355
	Technical Support Fax	51 481 5470
	Customer Care Fax	51 481 5480
	Sales	0800 90 3390
<b>British Virgin Islands</b>	General Support	toll-free: 1-866-278-6820
<b>Brunei</b>  Country Code: <b>673</b>	Customer Technical Support (Penang, Malaysia)	604 633 4966
	Customer Service (Penang, Malaysia)	604 633 4949
	Transaction Sales (Penang, Malaysia)	604 633 4955
	Online Order Status: <a href="http://www.dell.ca/ostatus">www.dell.ca/ostatus</a>	
	AutoTech (automated technical support)	toll-free: 1-800-247-9362

<b>Canada (North York, Ontario)</b> International Access Code: <b>011</b>	Customer Care (Home Sales/Small Business)	toll-free: 1-800-847-4096
	Customer Care (med./large business, government)	toll-free: 1-800-326-9463
	Technical Support (Home Sales/Small Business)	toll-free: 1-800-847-4096
	Technical Support (med./large bus., government)	toll-free: 1-800-387-5757
	Sales (Home Sales/Small Business)	toll-free: 1-800-387-5752
	Sales (med./large bus., government)	toll-free: 1-800-387-5755
	Spare Parts Sales & Extended Service Sales	1 866 440 3355
<b>Cayman Islands</b>	General Support	1-800-805-7541
<b>Chile (Santiago)</b> Country Code: <b>56</b> City Code: <b>2</b>	Sales, Customer Support, and Technical Support	toll-free: 1230-020-4823
<b>China (Xiamen)</b> Country Code: <b>86</b> City Code: <b>592</b>	Technical Support website: <a href="http://support.dell.com.cn">support.dell.com.cn</a>	
	Technical Support E-mail: <a href="mailto:cn_support@dell.com">cn_support@dell.com</a>	
	Customer Care E-mail: <a href="mailto:customer_cn@dell.com">customer_cn@dell.com</a>	
	Technical Support Fax	592 818 1350
	Technical Support (Dell™ Dimension™ and Inspiron™)	toll-free: 800 858 2969
	Technical Support (OptiPlex™, Latitude™, and Dell Precision™)	toll-free: 800 858 0950
	Technical Support (servers and storage)	toll-free: 800 858 0960
	Technical Support (projectors, PDAs, switches, routers, and so on)	toll-free: 800 858 2920
	Technical Support (printers)	toll-free: 800 858 2311
	Customer Care	toll-free: 800 858 2060
	Customer Care Fax	592 818 1308
	Home and Small Business	toll-free: 800 858 2222
	Preferred Accounts Division	toll-free: 800 858 2557
	Large Corporate Accounts GCP	toll-free: 800 858 2055
	Large Corporate Accounts Key Accounts	toll-free: 800 858 2628
	Large Corporate Accounts North	toll-free: 800 858 2999
	Large Corporate Accounts North Government and Education	toll-free: 800 858 2955
	Large Corporate Accounts East	toll-free: 800 858 2020
	Large Corporate Accounts East Government and Education	toll-free: 800 858 2669
	Large Corporate Accounts Queue Team	toll-free: 800 858 2572
Large Corporate Accounts South	toll-free: 800 858 2355	
Large Corporate Accounts West	toll-free: 800 858 2811	
Large Corporate Accounts Spare Parts	toll-free: 800 858 2621	
<b>Colombia</b>	General Support	980-9-15-3978
<b>Costa Rica</b>	General Support	0800-012-0435
<b>Czech Republic (Prague)</b> International Access Code: <b>00</b> Country Code: <b>420</b>	Website: <a href="http://support.euro.dell.com">support.euro.dell.com</a>	
	E-mail: <a href="mailto:czech_dell@dell.com">czech_dell@dell.com</a>	
	Technical Support	22537 2727
	Customer Care	22537 2707
	Fax	22537 2714
	Tech Fax	22537 2728
	Switchboard	22537 2711
<b>Denmark (Copenhagen)</b> International Access Code: <b>00</b> Country Code: <b>45</b>	Website: <a href="http://support.euro.dell.com">support.euro.dell.com</a>	
	E-mail: <a href="mailto:support.euro.dell.com/dk/da/emailldell/">support.euro.dell.com/dk/da/emailldell/</a>	
	Technical Support	7023 0182
	Customer Care (Relational)	7023 0184
	Home/Small Business Customer Care	3287 5505
	Switchboard (Relational)	3287 1200
	Switchboard Fax (Relational)	3287 1201
	Switchboard (Home/Small Business)	3287 5000
Switchboard Fax (Home/Small Business)	3287 5001	
<b>Dominica</b>	General Support	toll-free: 1-866-278-6821
<b>Dominican Republic</b>	General Support	1-800-148-0530
<b>Ecuador</b>	General Support	toll-free: 999-119
<b>El Salvador</b>	General Support	01-899-753-0777

<b>Finland (Helsinki)</b> International Access Code: <b>990</b> Country Code: <b>358</b> City Code: <b>9</b>	Website: <b>support.euro.dell.com</b>	
	E-mail: <b>support.euro.dell.com/fi/fi/emaildell/</b>	
	Technical Support	09 253 313 60
	Customer Care	09 253 313 38
	Fax	09 253 313 99
	Switchboard	09 253 313 00
<b>France (Paris) (Montpellier)</b> International Access Code: <b>00</b> Country Code: <b>33</b> City Codes: <b>(1) (4)</b>	Website: <b>support.euro.dell.com</b>	
	E-mail: <b>support.euro.dell.com/fr/fr/emaildell/</b>	
	<b>Home and Small Business</b>	
	Technical Support	0825 387 270
	Customer Care	0825 823 833
	Switchboard	0825 004 700
	Switchboard (calls from outside of France)	04 99 75 40 00
	Sales	0825 004 700
	Fax	0825 004 701
	Fax (calls from outside of France)	04 99 75 40 01
	<b>Corporate</b>	
	Technical Support	0825 004 719
	Customer Care	0825 338 339
	Switchboard	01 55 94 71 00
	Sales	01 55 94 71 00
Fax	01 55 94 71 01	
<b>Germany (Langen)</b> International Access Code: <b>00</b> Country Code: <b>49</b> City Code: <b>6103</b>	Website: <b>support.euro.dell.com</b>	
	E-mail: <b>tech_support_central_europe@dell.com</b>	
	Technical Support	06103 766-7200
	Home/Small Business Customer Care	0180-5-224400
	Global Segment Customer Care	06103 766-9570
	Preferred Accounts Customer Care	06103 766-9420
	Large Accounts Customer Care	06103 766-9560
	Public Accounts Customer Care	06103 766-9555
	Switchboard	06103 766-7000
<b>Greece</b> International Access Code: <b>00</b> Country Code: <b>30</b>	Website: <b>support.euro.dell.com</b>	
	E-mail: <b>support.euro.dell.com/gr/en/emaildell/</b>	
	Technical Support	00800-44 14 95 18
	Gold Service Technical Support	00800-44 14 00 83
	Switchboard	2108129810
	Gold Service Switchboard	2108129811
	Sales	2108129800
Fax	2108129812	
<b>Grenada</b>	General Support	toll-free: 1-866-540-3355
<b>Guatemala</b>	General Support	1-800-999-0136
<b>Guyana</b>	General Support	toll-free: 1-877-270-4609
<b>Hong Kong</b> International Access Code: <b>001</b> Country Code: <b>852</b>	Website: <b>support.ap.dell.com</b>	
	Technical Support E-mail: <b>apsupport@dell.com</b>	
	Technical Support (Dimension and Inspiron)	2969 3188
	Technical Support (OptiPlex, Latitude, and Dell Precision)	2969 3191
	Technical Support (PowerApp™, PowerEdge™, PowerConnect™, and PowerVault™)	2969 3196
	Customer Care	3416 0910
	Large Corporate Accounts	3416 0907
	Global Customer Programs	3416 0908
	Medium Business Division	3416 0912
Home and Small Business Division	2969 3105	
<b>India</b>	Technical Support	1600 33 8045
	Sales (Large Corporate Accounts)	1600 33 8044
	Sales (Home and Small Business)	1600 33 8046
	Website: <b>support.euro.dell.com</b>	
	E-mail: <b>dell_direct_support@dell.com</b>	
	Technical Support	1850 543 543



<b>Ireland (Cherrywood)</b> International Access Code: <b>16</b> Country Code: <b>353</b> City Code: <b>1</b>	U.K. Technical Support (dial within U.K. only)	0870 908 0800
	Home User Customer Care	01 204 4014
	Small Business Customer Care	01 204 4014
	U.K. Customer Care (dial within U.K. only)	0870 906 0010
	Corporate Customer Care	1850 200 982
	Corporate Customer Care (dial within U.K. only)	0870 907 4499
	Ireland Sales	01 204 4444
	U.K. Sales (dial within U.K. only)	0870 907 4000
	Fax/Sales Fax	01 204 0103
Switchboard	01 204 4444	
<b>Italy (Milan)</b> International Access Code: <b>00</b> Country Code: <b>39</b> City Code: <b>02</b>	Website: <a href="http://support.euro.dell.com">support.euro.dell.com</a>	
	E-mail: <a href="mailto:support.euro.dell.com/it/it/emaidell/">support.euro.dell.com/it/it/emaidell/</a>	
	<b>Home and Small Business</b>	
	Technical Support	02 577 826 90
	Customer Care	02 696 821 14
	Fax	02 696 821 13
	Switchboard	02 696 821 12
	<b>Corporate</b>	
	Technical Support	02 577 826 90
Customer Care	02 577 825 55	
Fax	02 575 035 30	
Switchboard	02 577 821	
<b>Jamaica</b>	General Support (dial from within Jamaica only)	1-800-682-3639
<b>Japan (Kawasaki)</b> International Access Code: <b>001</b> Country Code: <b>81</b> City Code: <b>44</b>	Website: <a href="http://support.jp.dell.com">support.jp.dell.com</a>	
	Technical Support (servers)	toll-free: 0120-198-498
	Technical Support outside of Japan (servers)	81-44-556-4162
	Technical Support (Dimension and Inspiron)	toll-free: 0120-198-226
	Technical Support outside of Japan (Dimension and Inspiron)	81-44-520-1435
	Technical Support (Dell Precision, OptiPlex, and Latitude)	toll-free: 0120-198-433
	Technical Support outside of Japan (Dell Precision, OptiPlex, and Latitude)	81-44-556-3894
	Technical Support (PDAs, projectors, printers, routers)	toll-free: 0120-981-690
	Technical Support outside of Japan (PDAs, projectors, printers, routers)	81-44-556-3468
	Faxbox Service	044-556-3490
	24-Hour Automated Order Service	044-556-3801
	Customer Care	044-556-4240
	Business Sales Division (up to 400 employees)	044-556-1465
	Preferred Accounts Division Sales (over 400 employees)	044-556-3433
	Large Corporate Accounts Sales (over 3500 employees)	044-556-3430
	Public Sales (government agencies, educational institutions, and medical institutions)	044-556-1469
	Global Segment Japan	044-556-3469
Individual User	044-556-1760	
Switchboard	044-556-4300	
<b>Korea (Seoul)</b> International Access Code: <b>001</b> Country Code: <b>82</b> City Code: <b>2</b>	Technical Support	toll-free: 080-200-3800
	Sales	toll-free: 080-200-3600
	Customer Service (Penang, Malaysia)	604 633 4949
	Fax	2194-6202
	Switchboard	2194-6000
Technical Support (Electronics and Accessories)	toll-free: 080-200-3801	
<b>Latin America</b>	Customer Technical Support (Austin, Texas, U.S.A.)	512 728-4093
	Customer Service (Austin, Texas, U.S.A.)	512 728-3619
	Fax (Technical Support and Customer Service) (Austin, Texas, U.S.A.)	512 728-3883
	Sales (Austin, Texas, U.S.A.)	512 728-4397
	SalesFax (Austin, Texas, U.S.A.)	512 728-4600 or 512 728-3772
<b>Luxembourg</b>	Website: <a href="http://support.euro.dell.com">support.euro.dell.com</a>	
	E-mail: <a href="mailto:tech_be@dell.com">tech_be@dell.com</a>	
	Technical Support (Brussels, Belgium)	3420808075

International Access Code: <b>00</b> Country Code: <b>352</b>	Home/Small Business Sales (Brussels, Belgium)	toll-free: 080016884
	Corporate Sales (Brussels, Belgium)	02 481 91 00
	Customer Care (Brussels, Belgium)	02 481 91 19
	Fax (Brussels, Belgium)	02 481 92 99
	Switchboard (Brussels, Belgium)	02 481 91 00
Macao Country Code: <b>853</b>	Technical Support	toll-free: 0800 105
	Customer Service (Xiamen, China)	34 160 910
	Transaction Sales (Xiamen, China)	29 693 115
Malaysia (Penang) International Access Code: <b>00</b> Country Code: <b>60</b> City Code: <b>4</b>	Website: <b>support.ap.dell.com</b>	
	Technical Support (Dell Precision, OptiPlex, and Latitude)	toll-free: 1 800 88 0193
	Technical Support (Dimension, Inspiron, and Electronics and Accessories)	toll-free: 1 800 88 1306
	Technical Support (PowerApp, PowerEdge, PowerConnect, and PowerVault)	toll-free: 1800 88 1386
	Customer Service (Penang, Malaysia)	04 633 4949
	Transaction Sales	toll-free: 1 800 888 202
	Corporate Sales	toll-free: 1 800 888 213
Mexico International Access Code: <b>00</b> Country Code: <b>52</b>	Customer Technical Support	001-877-384-8979 or 001-877-269-3383
	Sales	50-81-8800 or 01-800-888-3355
	Customer Service	001-877-384-8979 or 001-877-269-3383
	Main	50-81-8800 or 01-800-888-3355
Montserrat	General Support	toll-free: 1-866-278-6822
Netherlands Antilles	General Support	001-800-882-1519
Netherlands (Amsterdam) International Access Code: <b>00</b> Country Code: <b>31</b> City Code: <b>20</b>	Website: <b>support.euro.dell.com</b>	
	Technical Support	020 674 45 00
	Technical Support Fax	020 674 47 66
	Home/Small Business Customer Care	020 674 42 00
	Relational Customer Care	020 674 4325
	Home/Small Business Sales	020 674 55 00
	Relational Sales	020 674 50 00
	Home/Small Business Sales Fax	020 674 47 75
	Relational Sales Fax	020 674 47 50
	Switchboard	020 674 50 00
	Switchboard Fax	020 674 47 50
New Zealand International Access Code: <b>00</b> Country Code: <b>64</b>	E-mail (New Zealand): nz_tech_support@dell.com	
	E-mail (Australia): au_tech_support@dell.com	
	Technical Support (for desktop and portable computers)	toll-free: 0800 446 255
	Technical Support (for servers and workstations)	toll-free: 0800 443 563
	Home and Small Business	0800 446 255
	Government and Business	0800 444 617
	Sales	0800 441 567
	Fax	0800 441 566
Nicaragua	General Support	001-800-220-1006
Norway (Lysaker) International Access Code: <b>00</b> Country Code: <b>47</b>	Website: <b>support.euro.dell.com</b>	
	E-mail: <b>support.euro.dell.com/no/no/emaildell/</b>	
	Technical Support	671 16882
	Relational Customer Care	671 17575
	Home/Small Business Customer Care	23162298
	Switchboard	671 16800
	Fax Switchboard	671 16865
Panama	General Support	001-800-507-0962
Peru	General Support	0800-50-669
Poland (Warsaw) International Access Code: <b>011</b>	Website: <b>support.euro.dell.com</b>	
	E-mail: <b>pl_support_tech@dell.com</b>	
	Customer Service Phone	57 95 700
	Customer Care	57 95 999

Country Code: <b>48</b> City Code: <b>22</b>	Sales	57 95 999
	Customer Service Fax	57 95 806
	Reception Desk Fax	57 95 998
	Switchboard	57 95 999
<b>Portugal</b> International Access Code: <b>00</b> Country Code: <b>351</b>	Website: <a href="http://support.euro.dell.com">support.euro.dell.com</a>	
	E-mail: <a href="mailto:support.euro.dell.com/pt/en/emaildell/">support.euro.dell.com/pt/en/emaildell/</a>	
	Technical Support	707200149
	Customer Care	800 300 413
	Sales	800 300 410 or 800 300 411 or 800 300 412 or 21 422 07 10
	Fax	21 424 01 12
<b>Puerto Rico</b>	General Support	1-800-805-7545
<b>St. Kitts and Nevis</b>	General Support	toll-free: 1-877-441-4731
<b>St. Lucia</b>	General Support	1-800-882-1521
<b>St. Vincent and the Grenadines</b>	General Support	toll-free: 1-877-270-4609
<b>Singapore (Singapore)</b> International Access Code: <b>005</b> Country Code: <b>65</b>	Website: <a href="http://support.ap.dell.com">support.ap.dell.com</a>	
	Technical Support (Dimension, Inspiron, and Electronics and Accessories)	toll-free: 1800 394 7430
	Technical Support (OptiPlex, Latitude, and Dell Precision)	toll-free: 1800 394 7488
	Technical Support (PowerApp, PowerEdge, PowerConnect, and PowerVault)	toll-free: 1800 394 7478
	Customer Service (Penang, Malaysia)	604 633 4949
	Transaction Sales	toll-free: 1 800 394 7412
	Corporate Sales	toll-free: 1 800 394 7419
<b>Slovakia (Prague)</b> International Access Code: <b>00</b> Country Code: <b>421</b>	Website: <a href="http://support.euro.dell.com">support.euro.dell.com</a>	
	E-mail: <a href="mailto:czech_dell@dell.com">czech_dell@dell.com</a>	
	Technical Support	02 5441 5727
	Customer Care	420 22537 2707
	Fax	02 5441 8328
	Tech Fax	02 5441 8328
	Switchboard (Sales)	02 5441 7585
<b>South Africa (Johannesburg)</b> International Access Code: <b>09/091</b> Country Code: <b>27</b> City Code: <b>11</b>	Website: <a href="http://support.euro.dell.com">support.euro.dell.com</a>	
	E-mail: <a href="mailto:dell_za_support@dell.com">dell_za_support@dell.com</a>	
	Gold Queue	011 709 7713
	Technical Support	011 709 7710
	Customer Care	011 709 7707
	Sales	011 709 7700
	Fax	011 706 0495
	Switchboard	011 709 7700
<b>Southeast Asian and Pacific Countries</b>	Customer Technical Support, Customer Service, and Sales (Penang, Malaysia)	604 633 4810
<b>Spain (Madrid)</b> International Access Code: <b>00</b> Country Code: <b>34</b> City Code: <b>91</b>	Website: <a href="http://support.euro.dell.com">support.euro.dell.com</a>	
	E-mail: <a href="mailto:support.euro.dell.com/es/es/emaildell/">support.euro.dell.com/es/es/emaildell/</a>	
	<b>Home and Small Business</b>	
	Technical Support	902 100 130
	Customer Care	902 118 540
	Sales	902 118 541
	Switchboard	902 118 541
	Fax	902 118 539
	<b>Corporate</b>	
	Technical Support	902 100 130
	Customer Care	902 115 236
	Switchboard	91 722 92 00
	Fax	91 722 95 83
	<b>Sweden (Upplands Vasby)</b> International Access Code: <b>00</b> Country Code: <b>46</b> City Code: <b>8</b>	Website: <a href="http://support.euro.dell.com">support.euro.dell.com</a>
E-mail: <a href="mailto:support.euro.dell.com/se/sv/emaildell/">support.euro.dell.com/se/sv/emaildell/</a>		
Technical Support		08 590 05 199
Relational Customer Care		08 590 05 642
Home/Small Business Customer Care		08 587 70 527
Employee Purchase Program (EPP) Support		20 140 14 44
Technical Support Fax	08 590 05 594	

	Sales	08 590 05 185
<b>Switzerland (Geneva)</b> International Access Code: <b>00</b> Country Code: <b>41</b> City Code: <b>22</b>	Website: <b>support.euro.dell.com</b>	
	E-mail: Tech_support_central_Europe@dell.com	
	E-mail for French-speaking HSB and Corporate Customers: <b>support.euro.dell.com/ch/fr/emaildell/</b>	
	Technical Support (Home and Small Business)	0844 811 411
	Technical Support (Corporate)	0844 822 844
	Customer Care (Home and Small Business)	0848 802 202
	Customer Care (Corporate)	0848 821 721
	Fax	022 799 01 90
	Switchboard	022 799 01 01
<b>Taiwan</b> International Access Code: <b>002</b> Country Code: <b>886</b>	Website: <b>support.ap.dell.com</b>	
	E-mail: ap_support@dell.com	
	Technical Support (OptiPlex, Latitude, Inspiron, Dimension, and Electronics and Accessories)	toll-free: 00801 86 1011
	Technical Support (PowerApp, PowerEdge, PowerConnect, and PowerVault)	toll-free: 00801 60 1256
	Transaction Sales	toll-free: 00801 65 1228
<b>Thailand</b> International Access Code: <b>001</b> Country Code: <b>66</b>	Corporate Sales	toll-free: 00801 651 227
	Website: <b>support.ap.dell.com</b>	
	Technical Support (OptiPlex, Latitude, and Dell Precision)	toll-free: 1800 0060 07
	Technical Support (PowerApp, PowerEdge, PowerConnect, and PowerVault)	toll-free: 1800 0600 09
	Customer Service (Penang, Malaysia)	604 633 4949
<b>Trinidad/Tobago</b>	Corporate Sales	toll-free: 1800 006 009
	Transaction Sales	toll-free: 1800 006 006
<b>Turks and Caicos Islands</b>	General Support	1-800-805-8035
<b>U.K. (Bracknell)</b> International Access Code: <b>00</b> Country Code: <b>44</b> City Code: <b>1344</b>	General Support	toll-free: 1-866-540-3355
	Website: <b>support.euro.dell.com</b>	
	Customer Care website: <b>support.euro.dell.com/uk/en/ECare/Form/Home.asp</b>	
	E-mail: dell_direct_support@dell.com	
	Technical Support (Corporate/Preferred Accounts/PAD [1000+ employees])	0870 908 0500
	Technical Support (direct and general)	0870 908 0800
	Global Accounts Customer Care	01344 373 186
	Home and Small Business Customer Care	0870 906 0010
	Corporate Customer Care	01344 373 185
	Preferred Accounts (500-5000 employees) Customer Care	0870 906 0010
	Central Government Customer Care	01344 373 193
	Local Government & Education Customer Care	01344 373 199
	Health Customer Care	01344 373 194
	Home and Small Business Sales	0870 907 4000
Corporate/Public Sector Sales	01344 860 456	
Home and Small Business Fax	0870 907 4006	
<b>Uruguay</b>	General Support	toll-free: 000-413-598-2521
	Automated Order-Status Service	toll-free: 1-800-433-9014
<b>U.S.A. (Austin, Texas)</b> International Access Code: <b>011</b> Country Code: <b>1</b>	AutoTech (portable and desktop computers)	toll-free: 1-800-247-9362
	<b>Consumer (Home and Home Office)</b>	
	Technical Support	toll-free: 1-800-624-9896
	Customer Service	toll-free: 1-800-624-9897
	DellNet™ Service and Support	toll-free: 1-877-Dellnet (1-877-335-5638)
	Employee Purchase Program (EPP) Customers	toll-free: 1-800-695-8133
	Financial Services website: <b>www.dellfinancialservices.com</b>	
	Financial Services (lease/loans)	toll-free: 1-877-577-3355
	Financial Services (Dell Preferred Accounts [DPA])	toll-free: 1-800-283-2210
	<b>Business</b>	
	Customer Service and Technical Support	toll-free: 1-800-822-8965
	Employee Purchase Program (EPP) Customers	toll-free: 1-800-695-8133
	Printers and Projectors Technical Support	toll-free: 1-877-459-7298
	<b>Public (government, education, and healthcare)</b>	



	Customer Service and Technical Support	toll-free: 1-800-456-3355
	Employee Purchase Program (EPP) Customers	toll-free: 1-800-234-1490
	Dell Sales	toll-free: 1-800-289-3355 or toll-free: 1-800-879-3355
	Dell Outlet Store (Dell refurbished computers)	toll-free: 1-888-798-7561
	Software and Peripherals Sales	toll-free: 1-800-671-3355
	Spare Parts Sales	toll-free: 1-800-357-3355
	Extended Service and Warranty Sales	toll-free: 1-800-247-4618
	Fax	toll-free: 1-800-727-8320
	Dell Services for the Deaf, Hard-of-Hearing, or Speech-Impaired	toll-free: 1-877-DELLTTY (1-877-335-5889)
<b>U.S. Virgin Islands</b>	General Support	1-877-673-3355
<b>Venezuela</b>	General Support	8001-3605

[Back to Contents Page](#)

## Dell™ PowerEdge™ 6850 Systems Installation and Troubleshooting Guide

---

### Notes, Notices, and Cautions

-  **NOTE:** A NOTE indicates important information that helps you make better use of your computer.
  -  **NOTICE:** A NOTICE indicates either potential damage to hardware or loss of data and tells you how to avoid the problem.
  -  **CAUTION:** A CAUTION indicates a potential for property damage, personal injury, or death.
- 

### Abbreviations and Acronyms

For a complete list of abbreviations and acronyms, see the Glossary in your *User's Guide*.

---

---

---

---

Information in this document is subject to change without notice.  
© 2004 Dell Inc. All rights reserved.

Reproduction in any manner whatsoever without the written permission of Dell Inc. is strictly forbidden.

Trademarks used in this text: *Dell*, the *DELL* logo, *PowerEdge*, *PowerVault*, *Dell OpenManage*, *Dimension*, *Inspiron*, *OptiPlex*, *Latitude*, *Dell Precision*, *PowerApp*, *PowerConnect*, and *DellNet* are trademarks of Dell Inc.; *Intel* is a registered trademark and *Xeon* is a trademark of Intel Corporation.

Other trademarks and trade names may be used in this document to refer to either the entities claiming the marks and names or their products. Dell Inc. disclaims any proprietary interest in trademarks and trade names other than its own.

December 2004 P/N H2147 Rev. A00

---